

ENERGY SCIENCE REPORT NO. 2

POWER FROM ICE: THERMOELECTRICS: PART I

by

HAROLD ASPDEN

Sabberton Publications
P.O. Box. 35, Southampton SO16 7RB, England
Fax: Int+44-2380-769-830

ISBN 0 85056 023 3

ENERGY SCIENCE REPORT NO. 2

POWER FROM ICE: THERMOELECTRICS: PART I

© HAROLD ASPDEN, 1994

Contents

Section Title	page
Introduction	1
Concerning the Patent Rights	2
Development Status: May 1994	3
APPENDIX I: Schedule of Patents	13
APPENDIX II: 'Solid-State Thermoelectric Refrigeration,' IECEC paper: Atlanta, Georgia: August 1993	17
APPENDIX III: The Strachan-Aspden Invention: Operating Principles: October 1989 Report	26
APPENDIX IV: The Strachan-Aspden Invention: Test Results: October 1989 Report	41
APPENDIX V: The Strachan-Aspden Invention: Paper on Thermoelectric Power Anomaly: October 1989 Report	55
APPENDIX VI: Thermoelectric Experimental Device Construction: Strachan: February 1994	62-71

POWER FROM ICE

Introduction

This Energy Science Report summarizes the development status of the Strachan-Aspden thermoelectric energy conversion technology as of May 1994. Onward research from that date is the subject of Energy Science Report No. 3.

The basic invention is the brainchild of its coinventors Dr. Harold Aspden of Southampton, England and John Scott Strachan of Edinburgh, Scotland and it dates from their first meeting in Canada on the occasion of a New Energy Technology Symposium held in 1988 under the auspices of the Planetary Association for Clean Energy.

In its conception, the invention merges the technical disciplines of magnetism (Aspden) and piezoelectricity (Strachan) in a structure which exploits, first and foremost, the thermoelectric properties of metal. In its onward development and promotion, the respective professional skills of the two inventors were brought to bear in laboratory assembly (Strachan) and patenting (Aspden). Geographic separation by 420 miles has precluded a close working relationship in pursuing this project in a normal technological development sense, it being a private venture by two individuals, each having other unrelated technical interests.

In the event, what is an extremely important inventive contribution, that potentially can provide the non-polluting refrigeration technology of the future, has remained undeveloped, notwithstanding some small external R&D funding that has been of assistance to Strachan.

There are not, of record and suitable for issuance, any detailed experimental tests or results provided by Strachan. Almost all the documentary material that has been made available until now has been generated by this author (Aspden), mainly in a patent attorney or promotional capacity. Much of this latter information is the basis of this Report. One appended item that is new at this time is the account which Strachan prepared in February 1994 describing the polymer PVDF structure and fabrication of the first and third demonstration prototypes which he built. The issuance of this Report at this time follows the recent grant of the relevant U.S. Patent No. 5,288,336 dated February 22, 1994.

The object of this Report, therefore, is to arouse interest in the Strachan-Aspden invention in those corporations having the necessary R&D resources or ability to fund such

R&D in academic establishment laboratories with a view to the disposition of the patents involved.

Concerning the Patent Rights

[Note added June 2003 when this Report is made available on the author's websites www.energyscience.co.uk and www.aspden.org. The comments about patent rights which follow no longer apply as the patents involved were not kept alive, owing to lack of interest by prospective developers having the necessary disposition to fund the onward research needed. However, for the record, the text below remains unamended from its initial form as published in 1994.]

The schedule of patents relating to the Strachan-Aspden technology forms APPENDIX I. The author, in his Attorney capacity representing the proprietor interest in these patents, is empowered to negotiate options or outright assignment. Based on the introductory technical briefing offered by this Energy Science Report, and the information now being incorporated in further reports, the author also makes himself available for some limited consultation on onward development by those parties who enter into the necessary Agreements.

The abstract and title page of the principal U.S. Patent, 5,288,336 is included in APPENDIX I and those interested in the detailed disclosure and claim cover will no doubt wish to acquire and inspect a copy of that published patent specification.

Essentially, the details of the operation and technology underlying the invention can be understood from the descriptive material provided later in this report, but there has been a shift in emphasis as to this author's technical appreciation underlying physical functioning of the invention and this features in certain additional patent applications which have been filed and which, though listed in APPENDIX I, will form the subject of Energy Science Report No. 3.

In order, however, to assist the reader who does inspect the primary U.S. Patent No. 5,288,336 and also U.S. Patent No. 5,065,085 and seeks a simple insight into how this author now views the underlying physics, the diagram in Fig. 1 below may serve.

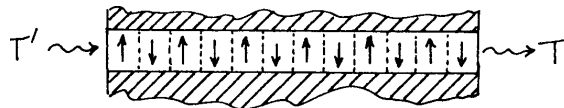

Fig. 1 Nernst EMFs induced in nickel by heat flow

When a temperature differential exists in a thin film of nickel sandwiched between dielectric insulation in a parallel plate capacitor, the heat flow carried by electrons is

deflected by the strong polarization fields in the oppositely polarized single magnetic domains that bridge the film thickness. This, by the thermoelectric phenomenon known as the Nernst Effect develops an electric field polarization as shown by the arrows. It is orthogonal with respect to the direction of heat flow and the magnetic polarization. It may then be understood how a lateral oscillation of current flow through the capacitor can choose a flow path on successive half cycles so as always to transfer charge across the metal plate electrodes to draw power from an assisting EMF by avoiding the path obstructed by an opposing EMF. Cooling must then result as that power transfers into the external circuit. The dielectric insulation obliges the heat flow in the nickel to remain orthogonal with the current flow direction and also with the magnetic polarization which is necessarily in-plane in the nickel.

Development Status: May 1994

[The figure references in this section apply to the patent specification drawings included at pages 7 and 8 of this Report]

There were three techniques in the original conception of the invention. The common feature was the idea of using a capacitive coupling to block heat transfer between the hot and cold heat sinks whilst contriving thermoelectric energy conversion. Strachan advised that all three had been tested experimentally and were viable.

The one ready for demonstration (the capacitor stack) was given preference for onward development. The strategy adopted was to file a first patent application showing capacitor use in the heat blocking sense (Figs. 1 to 4 of the 18 November 1988 patent filing - same as those in U.S. Patent No. 5,065,085) and a brief disclosure of the stack (Fig. 4) but not disclose the detailed assembly of the stack. A second U.K. application filed 5 December 1988 added Figs. 5 to 8 and covered that detail and described the prototype version of the stack as I understood it at the time.

In the event the capacitor heat blocking proved not to be of particular merit but we had a basic invention in the disclosure in that the confinement of heat flow to the bimetallic capacitor plates with transverse current oscillations gave remarkable results.

The subjects of Figs. 1 to 3 were not developed further, even though they have merit. I persisted in securing patent cover in U.K. and U.S.A., the latter, as just indicated, being granted as US Patent No. 5,065,085.

The patent cover which followed from the capacitor stack was adjusted and tailored to the diagnostic findings that emerged from the research on the second prototype and the international patent filing including US filing did not replicate the features of Fig. 7 or Fig. 8 or include the acoustic oscillation feature that was incorporated in the first prototype.

The First Prototype: September 1988

This was a capacitive polymer dielectric stack with bimetallic Al:Ni coatings and provision for acoustic oscillation of interleaved premagnetized magnetic recording strips (see Fig. 8).

Strachan has, only in February 1994, and in preparation for a visit from overseas by interested corporate project engineers, documented the detailed constructional techniques of that first (and later third) prototype. This forms APPENDIX VI.

Fabrication is very complicated and it is not suggested that the resulting devices did any more than prove that we have discovered an energy conversion principle that has very outstanding merit. The task ahead is to develop on the test findings of the much simplified second prototype.

The Basic Principles and the Second Prototype: October 1989

This was the technology on which the multi-national patent filing was based, claiming the priorities of the 18th November and 5th December 1988.

The principle is evident from the following diagram:

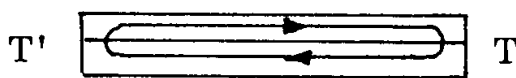

(a) Thermoelectric current flow: no transverse excitation

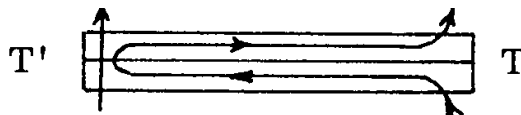

(b) Junction cooling on left with transverse up-current

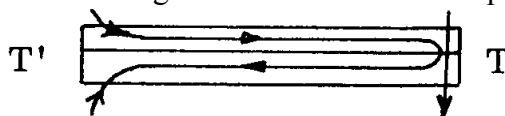

(c) Junction heating on right with transverse down-current

- Note:
- (1) We are using a.c. with negligible I^2R loss.
 - (2) The circulating current is that carried by heat flow (Thomson Effect - metals of opposite electrical polarity).
 - (3) The dynamic a.c. current interruption increases the thermoelectric power enormously (avoids junction cold spot formation).

At that time (October 1989), though the Nernst Effect was in mind and had been mentioned in connection with the disclosure in U.S. Patent No. 5,065,085 and though nickel, a ferromagnetic substance, was one of the two metals in the test device, it was not then

realised that the Nernst Effect might also play the key role in the functioning of that second prototype device.

The October 1989 status is evident from the Test Report (APPENDIX IV). APPENDIX V provides a scientific analysis of the cold spot problem).

The questions outstanding from those tests were:

- (1) What frequency could we reduce to and still get the high thermoelectric EMF? The cold spot theory implied that we could operate even below 1 kHz, but the capacitor coupling limited the transverse current and that suggested building a direct metal conductor coupling following contours of constant temperature - so as not to divert heat from the junctions.
- (2) What thickness of metal film could we increase to whilst not losing efficiency? Note that the Thomson Effect circulation fixed the current that could flow transversely owing to the half-cycle cut-off.
- (3) Which metal combination was optimum?
- (4) What fabrication technique was best to ease manufacture and assure reliability?
- (5) Why was it that we seemed to be getting more transverse current flow than the design capacitance of the stack implied from the voltages we measured?

In the event, early in 1990, Strachan was obliged to abandon all work on the project and the development fell dormant. This was owing to business failure of the sponsors on an independent manufacturing venture but Strachan was then unable to demonstrate a working prototype and we were, in effect, then in a worse position than at our late-1988 start point.

The 1991/1992 Scenario

Not having the resources to set up an experimental programme myself, and especially as I had to sustain the costs of the patents I decided to publish in the hope of attracting interest from corporations. I had nothing to demonstrate.

My effort to publish in the Journal of Applied Physics caused a referee to say 'publish but provided more detail is given as to actual construction of the device', but the Editor felt my amended paper did not go far enough in that respect and so that initiative failed.

By year end 1991 I had an acceptance from a U.K. electronics magazine (the July 1992 article in Electronics and Wireless World) and had a paper scheduled for the 1992 International Energy Conversion Engineering Conference in San Diego.

The publicity in U.K. attracted corporate interest, and Strachan then took the initiative and assembled the third prototype. The showing of that impressed a major U.K. company interested in new energy development and they provided new funding for Strachan for a period of 8 months.

I made sure that the demonstration was recorded on video and this has proved helpful in talks with interested parties. My personal objective concerning onward development has been to see the test device operate without reliance on the capacitor fabrication, either by an alternative conductive coupling between the bimetallic laminations or by magnetic inductive energy transfer, i.e. by intercepting the thermoelectric current by an inductive back EMF.

By year-end 1992, after 4 months of the new funding, Strachan reported on a test whereby, given a temperature differential in the bimetallic lamination, the magnetic flux could be controlled at 20 kHz by an electric grid control. However, that research did not progress to his satisfaction and I have insufficient data for me to make sense of the outcome of the experiment. The funding for Strachan's research ceased at the end of April 1993.

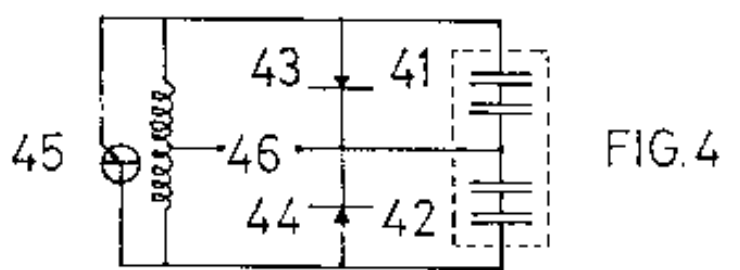
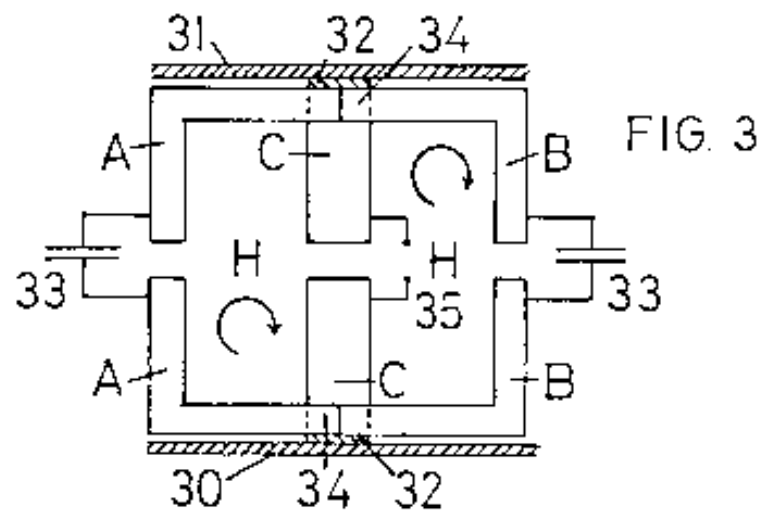
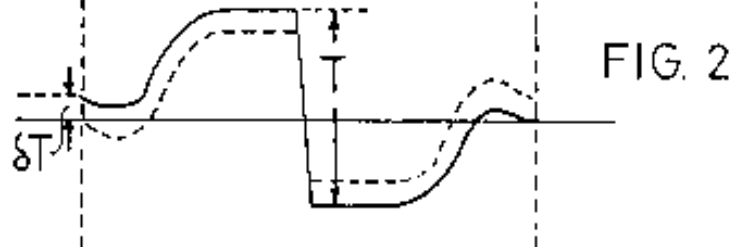
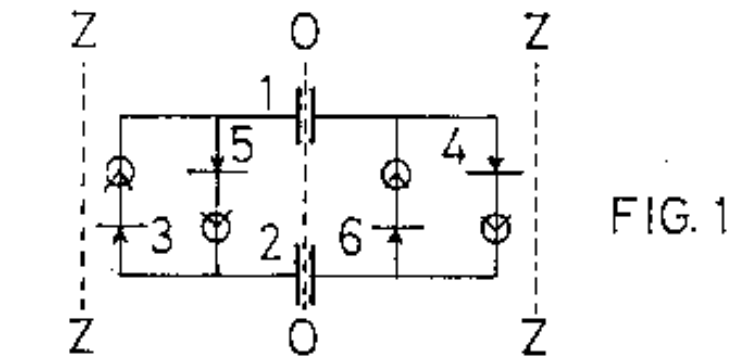

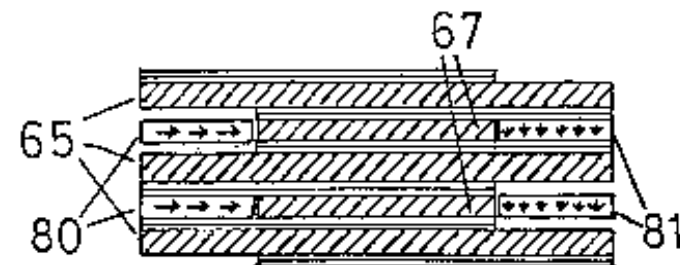
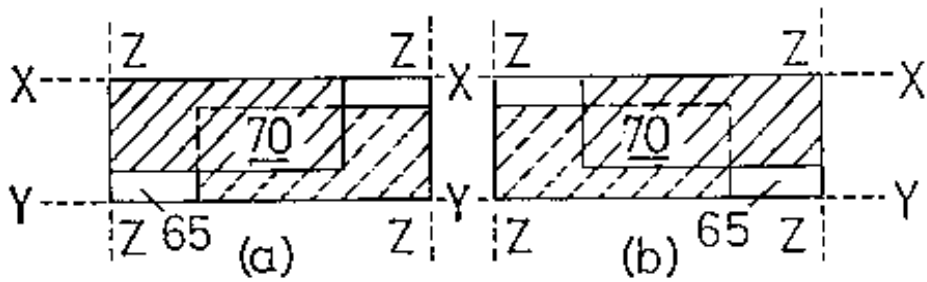
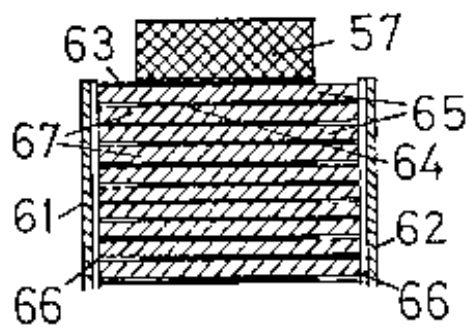
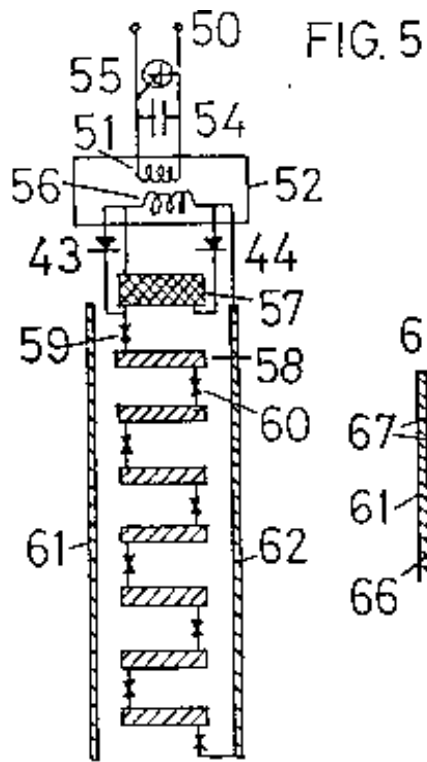

The Aspden Experiment

In September 1993 I decided to initiate my own small experiments, based on the approach I had been advocating, namely to build a magnetically inductive core system and feed in eddy-current heating to set up a temperature gradient in bimetallic laminations. The idea of this, regardless of application to refrigeration or power generation, was simply to have electrical control throughout the test and determine the relevance of the ferromagnetic property, metal thickness and excitation frequency.

The outcome of the first experiment has been described in Energy Science Report No. 1 and further onward experiments will be described in Energy Science Report No. 3.

However, some interesting problems have been encountered in the latter pursuit and the quest to operate in an all-metal high current mode with no dielectric laminations and capacitor drive, which is aimed mainly at solid-state electric power generation from input of heat at higher temperature than is normal where polymer dielectrics are used, may prove too demanding for this author's private research facilities.

Accordingly, as a guide to readers interested in pursuing the alternative capacitor construction based on that simple Nernst Effect principle as mentioned on page 2, the following analysis is included.

Capacitor Stack: Design Considerations

Consider nickel film to have a thickness δ cm and the form of a 1 cm by 1 cm square. Assume a temperature difference of 1° C from one edge to the opposite edge and denote the specific thermal conductivity of nickel as K watt-cm²/°C which implies a throughput heat flow of $K\delta$.

This heat flow is heat input loss if we do not intercept the heat and deploy it into electrical output.

The Nernst Effect has a coefficient for nickel which depends upon whether we use nickel I or nickel II, the latter being larger by a factor of nearly three. On the basis of the data of record from experiments by Zahn reported in Ann. der Phys. **14**, 886 (1904) and **16**, 149 (1905) on nickel we can reasonably assume that a 10 V per cm Nernst EMF is set up at right angles to the heat flow for each degree C temperature drop per cm.

It follows that the heat flow can be intercepted and deployed into output electrical power if we can provide for a transverse flow of current I amps without there being heat flow in that same transverse direction, with I given by the equality of $10I\delta$ and $K\delta$.

We see that the thickness δ makes no contribution to the heat to electricity conversion efficiency. This thickness of the nickel merely has to be small enough to assure the single

domain condition, say no greater than 50 to 200 microns depending upon the crystal size in the nickel.

The task is to secure the equality of K and $10I$, meaning that with the 1 degree C per cm gradient and K of the order of unity, I has to be 100 mA per sq. cm of capacitor area to get optimum operation. A higher temperature gradient requires a proportionally larger current flow.

The design consideration then centres on the a.c. operating frequency and capacitance of the structure. If the dielectric thickness is of the order of 10 microns and the dielectric constant is 10, both of which are demanding design parameters, then a capacitance of the order of 1 nanofarad applies to the 1 cm. square nickel plate electrodes used and operation at about 16 kHz will give a current of 0.1 mA per volt. It would need 1,000 V across that 10 micron dielectric to give the 100 mA current requirement.

This voltage stress requirement is too high and, also, there is another problem governing the combination of design parameters. This is that, if the thickness of the nickel is so much greater than the thickness of the dielectric, then the current 'sees' more a flow through the main surface of a ferromagnetic film and less the transfer of distributed charge on the surfaces of a dielectric. This can make the current bunch up by a pinch action in that 'negative' resistance flow path through the metal and, to avoid this, the dielectric has to be thicker than the nickel.

The design therefore proceeds by first deciding the operating limits on the voltage of a resonant capacitor stack using the inductance of the flow through the nickel in combination with the capacitance of the stack to determine that frequency. This sets the thickness of the dielectric. The nickel, if deposited on a substrate dielectric can be quite thin, say 5 microns, and it is this requirement for thin dielectric larger in thickness than the nickel, rather than the domain size factor, that obliges use of even thinner nickel films.

Note that the target of a 100% energy conversion efficiency then will depend primarily upon the scope for increasing the electric breakdown strength of the dielectric used, assuming simple metal parallel plate capacitance. Alternatively, in order then to bring to bear a suitable combination of parameters that allow moderate voltage gradients in a dielectric whilst allowing the current throughput to be adequate at a reasonable frequency, the way forward is to incorporate in the design the technology of electrolytic capacitors.

This, as this author sees the situation, is what Strachan did in building his prototype device using a PVDF polymer dielectric and it follows from this preamble discussion that those best able to develop the subject technology are those corporations who are already manufacturers of electrolytic capacitors.

Given then that the Strachan device did perform as a cooling device and as a heat pump able to convert heat into electricity one sees the prospect of developing a thermal

electrolytic capacitor that will convert heat to electricity or serve as a Nernst Effect heat pump with no Carnot limitation on performance.

The reason for this non-Carnot limitation is discussed in Energy Science Report No. 3, but it amounts to the observation that, with heat carried by electrons, the deflection of those electrons by a magnetic field occurs to bring them to thermal rest (effectively zero temperature K) as they transfer energy to the capacitor, followed by their recovery of heat by cooling the substance of their metal host. Carnot efficiency referenced on zero Kelvin is 100% as far as heat/electricity conversion is concerned.

It then needs little imagination for any enterprising research organization to see that such technology, if proven in this particular respect, can provide a complete answer to the world's future energy needs in that, by arranging a conventional Carnot-limited heat pump in back-to-back operation with the Strachan-Aspden non-Carnot-limited heat pump, and deploying atmospheric sources of heat one can generate electricity.

Hitherto the non-Carnot-limited conversion of heat into electricity has been elusive but it is possible in that it already occurs in practice in one half of a thermocouple circuit but there is there the concomitant requirement that the electricity has to close the circuit through the other thermocouple junction which makes the reverse conversion.

All that this Report is suggesting here is that the evidence from the transverse-to-heat-flow current excitation of a heated nickel-electrode capacitor shows how we can intercept the energy and make the non-Carnot-limited conversion without paying the full price of the reverse conversion at ambient temperature. The 'lower' temperature conversion occurs inside the metal as electrons are deprived transiently of their thermal energy. It occurs at positions in the metal where there is only one prevailing temperature. There is no way that Carnot criteria can apply unless there are two temperatures associated with that event and the only temperature that can differ from that prevailing in the metal is the temperature resulting when the electrons give up their thermal energy by being deflected into the charged condition at the interface surface of the nickel and the dielectric. That temperature has to be lower than the ambient temperature of the metal and the electron can only recover equilibrium and carry heat forward if it then takes heat away from the crystal body of the nickel.

Given that the ferromagnetic plate electrode is the seat of the action associated with the Nernst Effect it may seem that there is no need to provide the bimetallic structure of the Strachan-Aspden embodiments. However, it is important to see that there is a two-fold benefit from the use of bimetallic laminations. Firstly, the second metal helps to spread the charge trapped at the interface between the metal and the dielectric and this allows it to participate more fully in the two-way oscillation of current flow. Secondly, the second metal brings to bear the Peltier Effect and this can help to sustain temperature gradients which activate the cooling. Note here that the first and third Strachan-built prototypes had an intrinsic design symmetry and an input current oscillation developed the cooling action with no input temperature gradient.

In other words, the use of bimetallic plate electrodes meant that the back-to-back action described above was at work in those devices.

This Report, therefore, highlights the importance of the Strachan-Aspden invention and hopefully will serve to excite the interest of those corporations having the resources needed for its onward development.

Energy Science Report No. 3 will be issued when this author has completed some further experiments and, in the meantime, some of the findings will be available in confidence to sponsors.

The APPENDIX sequence which follows comprises items written at different times as this project evolved and there are a few published articles and papers that are not included owing to the length of this Report.

It is believed, however, that what is described or identified in this Report will serve as a guide to would-be researchers who wish to become involved in this subject and should suffice as full information about the invention.

The prospective importance of this technology is so great, having regard to the need to avoid the pollution problems of existing refrigeration and energy generation technology, that it is hoped that others will take this project forward on their own initiative. Should any such researcher make progress in this regard, leading to demonstrable devices confirming the viability of the technology, then, so long as this author has control of the patent rights involved there is scope for merging interests in a joint venture.

So far as the availability of rights under the patents is concerned, enquiries from corporations are invited but no licence deals can be entered at this time as the object is to sell the patents outright as a total package, which means that licence dealings will be for the purchaser to determine.

This does not preclude an immediate undertaking in the nature of an option by which some nominal funding will secure a would-be developer, who already commands the necessary research facilities, an interest in the rights whilst evaluating the invention based on prototype building and testing.

Enquiries concerning the patent rights should be directed to me and enquiries concerning availability of Energy Science Reports should be directed to Sabberton Publications (see address below).

18th July 1994

DR. HAROLD ASPDEN
c/o SABBERTON PUBLICATIONS, P.O. BOX 35, SOUTHAMPTON, SO16 7RB,
ENGLAND. FAX: Int+44-23-8076-9830. TEL: Int+44-23-8076-9361.

APPENDIX I

Schedule of Patents

Patent applications listed as 1-10 below all have the title:
 "Thermoelectric Energy Conversion"
 and all were filed naming H. Aspden and J. S. Strachan as co-inventors. Dr. Harold Aspden purchased from Strachan-Aspden Limited all rights in these applications on 12th January 1992. This company, registered in Scotland, was dissolved in July 1992, as it had become more expedient to operate from a company, Thermodynamics Limited, registered in England at Dr. Aspden's address.

1. U.K. Patent Application No.:8,826,952
 Date of Filing: 18th November 1988
 Grant as U.K. Patent No:2,225,161
2. U.K. Patent Application No.:8,828,307
 Date of Filing:5th December 1988
 [This served only as an international priority document for listed applications 3-4 & 6-10 below.]
3. U.K. Patent Application No.:8,920,580
 Date of Filing:12th September 1989
 Grant as U.K. Patent No:2,227,881
4. European Patent Appln. No.:89,311,559.2
 Date of Filing:8th November 1989
 Published Specification No:0369670
 Countries designated: Austria, Belgium, Switzerland, Germany, Spain, France
 United Kingdom, Italy, Lichtenstein, Luxembourg, Netherlands and Sweden
 [Presently pending]
5. U.S. Patent Application No.:07/429608
 Date of Filing: 31st October 1989
 Grant as U.S. Patent No:5,065,085
 Date of Grant:12th November 1991
6. U.S. Patent Application No.:07/439,829
 Date of Filing: 20th November 1989
 Grant as U.S. Patent No:5,288,336
 Date of Grant:22 February 1994

7. Japanese Patent Appln. No.:1-299481
Date of Filing: 17th November 1989
[Presently pending]
8. Canadian Patent Appln. No.:2,003,318-5
Date of Filing: 17th November 1989
[Presently pending]
9. Australian Pat. Appln. No.:44771/89
Date of Filing: 17th November 1989
Grant as Australian Pat. No:622,239
10. Eire Patent Appln. No.: 3677/89
Date of Filing: 17th November 1989
[Presently pending]

The following patent rights are currently in process. With the exception of the application identifying Thermodynamics Limited as applicant (sole inventor J. S. Strachan) all these are registered in the name of Dr. Harold Aspden as applicant and sole inventor. Dr. Aspden is empowered to negotiate rights under patents owned by Thermodynamics Limited.

11. U.K. Patent Application No:9,212,818
Date of Filing:17th June 1992
Published Specification No:2,267,995
[Presently pending]
12. U.K. Patent Application No:9,302,354
Date of Filing:6th February 1993
Applicant: Thermodynamics Ltd.
[Presently pending]
13. U.S. Patent Application No:08/018281
Date of Filing:16th February 1993
[Presently pending]
14. U.K. Patent Application No:9,321,036
Date of Filing:12th October 1993
[Presently pending]

The above is the status as at 18th July 1994.



US05288336A

United States Patent [19]

Strachan et al.

[11] Patent Number: 5,288,336

[45] Date of Patent: Feb. 22, 1994

[54] THERMOELECTRIC ENERGY CONVERSION

[73] Inventors: John S. Strachan, Edinburgh, Scotland; Harold Aspden, Southampton, England

[71] Assignee: Dr. Harold Aspden, Chilworth

[21] Appl. No.: 439,829

[22] Filed: Nov. 20, 1989

[30] Foreign Application Priority Data

Nov. 18, 1988 [GB]	United Kingdom	8676952
Dec. 5, 1988 [GB]	United Kingdom	8638307
Sep. 12, 1989 [GB]	United Kingdom	8920581

[51] Int. Cl. 2 H01H 35/04

[52] U.S. Cl. 336/200; 336/203; 336/204; 336/205; 336/211; 336/212; 336/224; 336/225; 336/226

[58] Field of Search 336/200, 201, 204, 205, 336/206, 208, 211, 212, 224, 225, 226, 227; 332/2 R, 310/40a

[56] References Cited

U.S. PATENT DOCUMENTS

1,809,475	6/1931	Dowler, Jr.	315/55
2,139,504	12/1938	King	358/28
2,939,553	10/1960	Frits	67/5
2,944,404	7/1960	Frits	67/5
2,981,775	6/1961	Rachman et al.	136/5
3,234,245	11/1966	Notlage	136/212
3,441,449	4/1968	Green	136/201
3,460,015	8/1969	Hines	318/111
3,969,349	7/1976	Thomas et al.	336/225
3,972,904	6/1976	Kessler	336/294
4,276,441	6/1981	Wilson	336/206
4,492,805	1/1985	Dalcherg	336/212
4,651,350	12/1988	Gerstman et al.	336/225

4,774,994	10/1988	Diller et al.	334/239
4,786,335	11/1988	Knowles	336/214
4,828,627	5/1989	Conery	336/201

FOREIGN PATENT DOCUMENTS

142829	11/1901	Fed. Rep. of Germany	336/210
320791	8/1931	Fed. Rep. of Germany	
253814	2/1960	Fed. Rep. of Germany	
3523723	1/1967	Fed. Rep. of Germany	
3627747	3/1987	Fed. Rep. of Germany	
61,384976	12/1988	Japan	336/235
1-206676	8/1989	Japan	336/236
2-103969	4/1990	Japan	336/201
1016102	1/1966	United Kingdom	

OTHER PUBLICATIONS

- UK Search Report, Jan. 30, 1990, 1 page
- EPO Search Report, Mar. 31, 1992, 1 page
- Annex in EPO on EP Appl. Nu. 89311559.2, 1 page

Primary Examiner—Donald P. Walsh
 Assistant Examiner—Christian D. Carroll
 Attorney, Agent, or Firm—Raney & Prestia

[57] ABSTRACT

A thermopile 30 comprises a stacked assembly of bimetallic layers in which there is full conductor interfacial contact over the distance separating hot and cold surfaces 31, 32. The assembly may include dielectric layers forming a capacitor stack. A C current through the stack is matched in strength to the Seebeck-generated thermoelectric current circulating in each bimetallic layer. The resulting current snakes through the stack to cause Peltier cooling at one heat surface and heating at the other. A C oscillator at a kilocycle frequency enhances the energy conversion efficiency as does heat flow parallel with the junction interface.

12 Claims, 2 Drawing Sheets

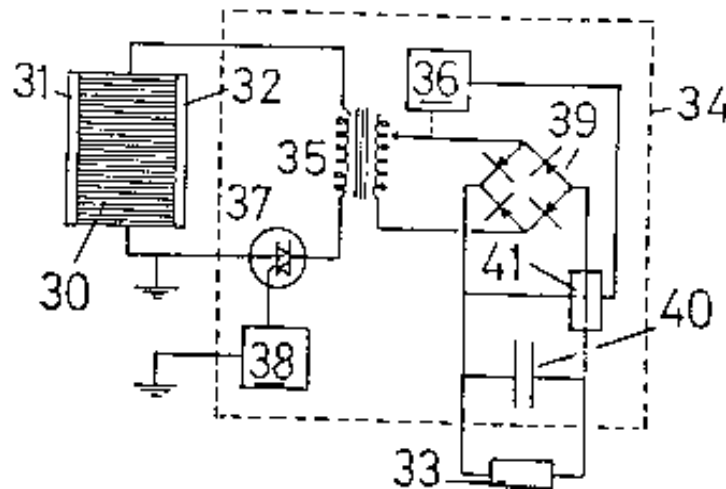

United States Patent (19)

Aspden et al.

[11] **Patent Number:** **5,065,085**

[45] **Date of Patent:** **Nov. 12, 1991**

[54] **THERMOELECTRIC ENERGY CONVERSION**

[75] **Inventors:** **Harold Aspden, Chisworth, Isle of Man; John S. Strachan, Edinburgh, Scotland**

[73] **Assignee:** **Strachan-Aspden Limited, Edinburgh, Scotland**

[21] **App. No.:** **429,608**

[23] **Filed:** **Oct. 31, 1989**

[30] **Foreign Application Priority Data**

Nov. 28, 1988 [GB] United Kingdom .. . 8874952

[51] **Int. Cl.:** .. . **H02N 3/00**

[52] **U.S. Cl.:** .. . **322/2 R; 310/306; 322/2 A**

[55] **Field of Search:** .. . **322/2 A; 2 R; 310/306**

[56] **References Cited**

U.S. PATENT DOCUMENTS

3,149,246 9/1964 Mason .. . 322/2 R X
3,199,302 6/1965 Rollinger et al. 322/2 R X

3,365,653 1/1968 Gabor et al. 322/2 R
4,094,515 1/1977 Yater .. . 322/2 R
4,368,416 1/1981 James .. . 322/2 R
4,419,617 12/1981 Reaz .. . 322/2 R

Primary Examiner—R. J. Hickey
Attorney, Agent, or Firm—Ratner & Prestis

[57] **ABSTRACT**

A thermoelectric energy converter incorporates thermocouples in a circuit carrying A. C. current via capacitors which provide electrical coupling but obstruct heat transfer between hot and cold junctions. The cyclic current oscillations through the capacitors are directed by special circuits so as to be rendered asymmetric as current oscillations through the thermoelectric junctions. One such circuit includes the use of a diode configuration regulating current flow through different thermoelectric junctions spaced apart in the thermal gradient. Another involves the action of a unidirectional magnetic field having a polarizing effect on a three-metal thermoelectric junction.

15 Claims, 1 Drawing Sheet

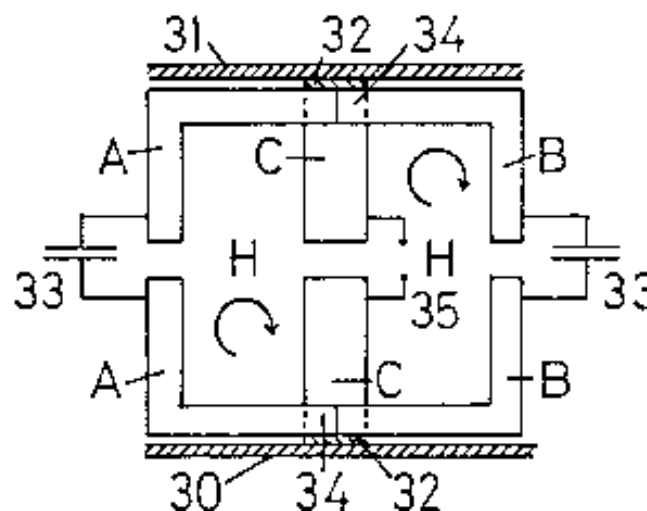

APPENDIX II

'Solid-State Thermoelectric Refrigeration'

[This is the text of a paper submitted to IECEC by H. Aspden and J. S. Strachan, a summary version of which was presented in person by Dr. H. Aspden at their 28th Intersociety Energy Conversion Engineering Conference held in Atlanta, Georgia, U.S.A., August 8-13, 1993.]

This paper reports progress on the development of a new solid-state refrigeration technique using base metal combinations in a thermopile.

Thermoelectric EMFs of $300 \mu\text{V}$ per degree C are obtained from metal combinations such as Al:Ni, assembled in a thermopile of novel structure. By providing for thermally driven Thomson Effect current circulation in loop circuit paths parallel with the temperature gradient between two heat sinks and also for superimposed transverse current flow driven through a very low resistance path by Peltier Effect EMF, an extremely efficient refrigeration process results.

With low temperature differentials, one implementation of the device operates at better than 70% of Carnot efficiency. It has the form of a small panel unit which operates in reversible mode, converting ice in a room temperature environment into an electrical power output and, conversely, with electrical input producing ice on one face of the panel while ejecting heat on the other face.

An extremely beneficial feature from a design viewpoint is the fact that the transverse excitation is an A.C. excitation, which suits the high current and low voltage features of the thermopile assembled as a stack within the panel.

A prototype demonstration device shows the extremely rapid speed at which ice forms, even when powered by a small electric battery, and, with the battery disconnected and replaced by an electric motor, how the ice thus formed melts to generate power driving the motor.

The subject is one of the two innovative concepts which were the subject of the paper No. 929474 entitled "Electronic Heat Engine" included in volume 4 of the Proceedings of the 1992 27th IECEC.

The technology to be described is seen as providing the needed answer to the CFC gas problem confronting refrigerator designers. From a conversion efficiency viewpoint this

device, which uses a solid-state panel containing no electronic components and a separate solid-state control unit which does contain electronic switch and transformer circuitry, outperforms conventional domestic refrigerators. Since it has no moving parts and contains no fluid, its fabrication and operational reliability promise to make this the dominant refrigeration technology of the future.

However, the scientific research and development of the underlying principles have a compelling interest and pose an immediate challenge inasmuch as recent diagnostic testing has pointed to a feature inherent in the prototype implementation that has even greater promise for future energy conversion technology.

This paper will address the subject in two parts. Firstly, the prototype will be described together with its performance data. Then, the ongoing development arising from the new discovery will be outlined.

General Operating Principle

The research was based on the use of a commercially available dielectric sheet substrate which had a surface layer of aluminium bonded to a PVDF polymer film by an intermediate layer of nickel. This gave basis for the idea of applying a temperature differential edge-to-edge to promote thermoelectric current circulation by differences in the Peltier EMFs at the opposite edges of the film.

However, the nature of this material, which was intended for use in a piezoelectric application and so had a metal surface film on both faces, gave scope for crosswise A.C. excitation, as if it was a parallel plate capacitor. Of interest to our research was the question of how the transverse A.C. flow of current through the bimetallic plates would interact with the thermoelectric current circulation.

Our finding was that the underlying D.C. current circulation which tapped into the heat source thermoelectrically was affected to an astounding degree once the A.C. excitation was applied. Whether we used frequencies of 500 kHz or 10 kHz, the thermoelectric Peltier EMF generated by the Al:Ni thermocouple was of the order of $300 \mu\text{V}/^\circ\text{C}$, which was 20 times the value normally expected from D.C. current activation.

It may be noted that, with the thermoelectric aspect in mind, the PVDF substrate film used was made to order, being specially coated with layers of nickel and aluminium to thicknesses of the order of 400 and 200 angstroms, respectively. This was intended to provide a better conductance matching for D.C. current flow in opposite directions in the two metals, it being optimum to design the test so that heat flow from the hot to the cold edges of the film would, by virtue of the Thomson Effect in these respectively electropositive and electronegative metals, suffice to convey equal currents in the two closed path sections without necessarily drawing on the transversely-directed Peltier EMF action.

It was hoped that the latter would contribute to the A.C. power circuit by a push-pull oscillatory current effect whereby heat energy and A.C. electric energy would become mutually convertible.

A full explanation of the commutating effect obtained by combining matched current flow of the transverse A.C. and the in-film circulating D.C. is given elsewhere (Aspden and Strachan, 1990 and, Aspden, 1992). However, Fig. 1 may suffice to represent schematically the functional operation.

Fig. 1(a) shows how bimetallic capacitor plates separated by dielectric substrates are located between hot (T') and cold (T) panel surfaces with electrical connections at the sides of the panel. Some of the plates are floating electrically, being coupled capacitatively in series, whereas the connections linking an external circuit through an SCR oscillator switch circuit form a parallel-connected capacitor system.

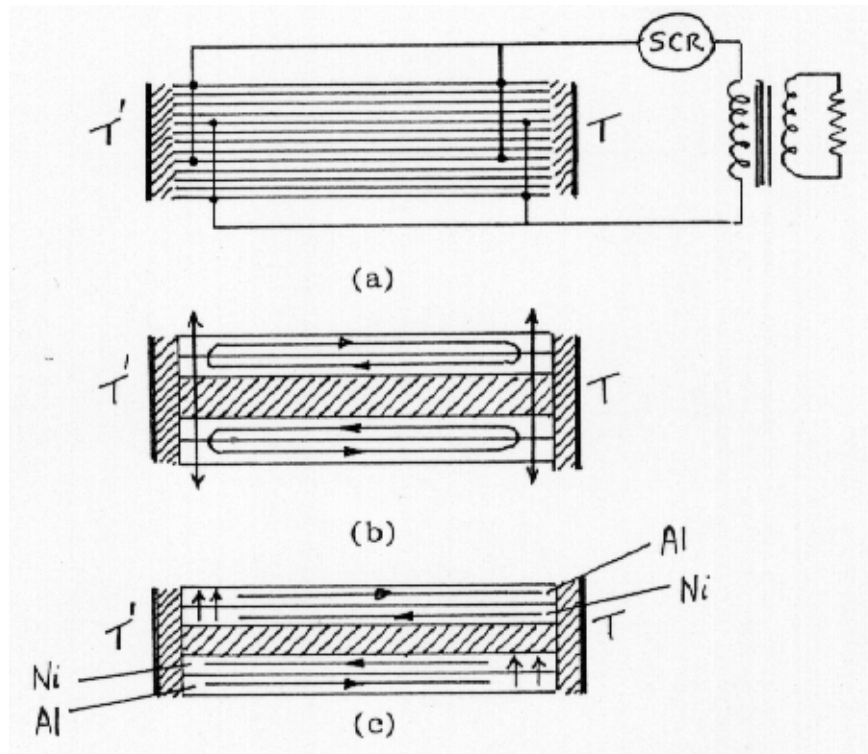

Fig. 1. Thermoelectric Circuit

Fig. 1(b) shows how D.C. current circulates in two bimetallic plates with a matching superimposed transverse A.C. current.

Fig. 1(c) applies when the A.C. current flow is in the upward direction.

The point is that, in alternate half cycles of the A.C., the current flow operates to block the D.C. flow at one or other of the thermocouple junctions whilst segregating the Peltier heating and cooling on their respective sides of the panel.

This has several very interesting consequences.

Firstly, it is found that the Peltier EMF is directed into the A.C. circuit, which being transverse to the thin metal film, is a low resistance circuit with high but virtually loss-free capacitative impedance.

Secondly, by diverting the electric power generated thermo-electrically, the D.C. current flow in the planes of the metal films was virtually exclusively that of heat-driven charge carriers. The current was sustained by the normal heat conduction loss through the metal and so did not detract from thermoelectric conversion efficiency by drawing upon the generated electric power.

Thirdly, and most unexpectedly, it was found that the current interruption precluded the formation of what we termed 'cold spots' at the Peltier cooled junctions. These latter spots arise in any normal thermocouple owing to concentrations of cold by Peltier cooling in a way which escalates so that the junction crossing temperature of a current is very much lower than that of the external heat sink condition. This stifles the thermoelectric power in the D.C. thermocouple and it was our discovery that the cyclic interruption of the flow by the transverse excitation technique accounts for the transition to the very high $300 \mu\text{V}/^\circ\text{C}$ thermoelectric power. The latter has been observed consistently in all three prototypes built to date and in diagnostic test rigs using the Al:Ni metal combination.

Fourthly, however, the eventual testing of operative devices, though performing overall within Carnot efficiency limitations, awakened special interest because there had to be something most unusual about the temperature profile through the device if the best performance measured was to be bounded by the Carnot condition.

Our research is now casting light upon that latter aspect and may herald a major breakthrough in energy conversion technology generally. However, even without the latter, the technology as developed to date does already justify commercial application in refrigeration systems and that is the primary focus of this paper.

Development History

The project has been slow to progress from its inception. One of us, Edinburgh scientist, J. S. Strachan (formerly with Pennwalt Corporation) assembled the device as a small flat module with 500 layers of bimetallic coated PVDF film. It was formed in a 20 by 25 series-parallel connection array which was a design compromise to enhance the capacitor

plate area, whilst matching the A.C. excitation voltage and the current rating to the switching circuitry and dielectric properties of the PVDF.

The device performed remarkably well when first tested, without requiring transitional stage-by-stage development to overcome problems. This had the effect of putting in our hands an invention which worked better than we had a right to expect but left us at the outset not knowing precisely how the different elements of the device were really contributing to the overall function.

More important, however, though the thermoelectric operational section of the device was at the heart of the action, the implementation which used the PVDF dielectric and a capacitative circuit posed problems that were seen as formidable but yet were only peripheral to the real invention. There was also some doubt as to whether the properties of the PVDF had a direct role in the energy conversion. There was difficulty in planning in cost terms the onward scaling-up development, owing to the perceived problems of switching high currents at the necessary voltage level and frequency.

Commercial pressures and the limited resources involved in what became a privately sponsored venture to develop the invention, combined with the barrier posed by the switch versus thermoelectric design conflict, halted R & D and led, sadly, to the project falling into a limbo state. This was until interest was aroused by the publication in the latter part of 1992 of the above-referenced 27th IECEC paper (Aspden, 1992) and by the article in *Electronics World* (Aspden 1992).

Sponsorship interest in the R & D concerning heat-to-electricity power conversion has now revived, led also by a demonstration made possible by the building of a third prototype which incorporates 1,000 PVDF substrate thermocouple capacitor plates and which provides the following test data.

Refrigeration Performance Data

All three prototype devices built to date exhibited a remarkable energy conversion efficiency. They all operated with different switching techniques and different design frequencies.

The first prototype was dual in operation in that it was bonded to a supporting room-temperature heat sink block and the application of ice to its upper face resulted in the generation of electricity sufficient to spin an electric motor. Conversely, the connection of a low voltage battery supply to the device resulted in water on the upper surface freezing very rapidly.

Had this first prototype been assembled the other way up it would have been easy to use calorimeter techniques and measure heat-electricity conversion in both operational modes. As it was, an attempt to chemically unbond the device from the heat sink resulted in corrosion damage which destroyed the device.

The second prototype was built, not for self-standing dual mode operation, but expressly to test the heat to electricity power generation efficiency with variable frequency. It was not self-oscillating and, as it did not function in refrigeration mode, it offered no test of refrigeration efficiency. It gave up to 73% of Carnot conversion efficiency in electric power generation with room temperature differentials of the order of 20° C. The recently constructed third prototype is superior in its electronic switching design and works well in both electric power generation and refrigeration modes.

There is, however, a circumstance about its operation which means that, for this particular demonstration prototype, according to its intrinsic magnetic polarization state, it works more efficiently in one or other of its conversion functions. This particular third prototype operated with higher Carnot-related efficiency in the electric power generation mode than in the refrigeration mode. Also, for the same reasons, and an additional factor concerning the power drawn by the electronics and impedance matching internal load circuitry, the overall external efficiencies are very much lower than can be expected in a fully engineered product implementation.

The refrigeration performance data presented below is, therefore, a worst-case situation and will, without question, be improved upon in the months following the date when this text is prepared.

The device included an SCR switching circuit which was self-tuning and ran as an oscillator powered from electricity generated from melting ice in power generation mode or drawing on a battery supply in the refrigeration mode. However, the power taken up by this circuitry was factored into the overall performance, meaning that the thermoelectric core of the device had to be functioning at higher efficiency. Because the electric demands of the circuit were high in relation to the small demonstration thermoelectric core unit to which it was coupled.

The active heat sink area of the device was about 20 sq. cm and a typical test involved a frozen block of 6 ml of water. A test performed after the lower heat sink had settled to a temperature of 25.6° C involved pressing the block of ice in a slightly melting state onto the upper heat sink with a polystyrene foam pad. The output voltage generated was fed to a 3 ohm load. It took 9 minutes for the ice to melt, during which time the measured output was a steady 0.67 V. These data show that a heat throughput of 3.7 watts generates electric power of 0.15 watts with temperatures for which Carnot efficiency is 8.6%. This indicates performance overall of 47% of the Carnot value.

It is noted that the 73% value obtained with the second prototype applies to a device which did not incorporate an oscillator demanding power but had simple electronic switching controlled by, and drawing negligible power from, an external function generator.

To test the refrigeration mode, 3 ml of water was poured into a container on the upper surface of the device and a battery supply of 7.2 V fed to the SCR resonator with a limiting

resistor now switched into circuit to protect the SCR during its turn-off. This resistor reduced the efficiency further. The circuit drew 6.3 watts and the water froze in 73 seconds.

Since convection was minimal the water closest to the surface froze first and this immediately formed an insulating barrier which would mean operation thereafter at a significant subzero temperature at that heat sink during most of those 73 seconds. However, the overall temperature difference ignoring that temperature drop in the ice was 26° C, associated with a cooling power of 13.7 watts for an electric power input of 6.3 watts. This represents a coefficient of performance of 2.17 or 21% of Carnot efficiency. Cooling action at below minus 40°C has been demonstrated.

Based on such worst-case data, which nevertheless applies to a simple solid-state device and compares well with the coefficient of performance data of domestic refrigerators, it can be assumed that the technology is capable of meeting production requirements of non-CFC refrigerators and domestic air conditioning equipment.

Outlook following Breakthrough Discovery

Diagnostic test work has proved that the device operation is independent from the piezoelectric or pyroelectric properties of the PVDF substrate used. Given that the action is truly that of the Peltier Effect, there should be current circulation in the bimetallic thin film productive of magnetic polarization. By detecting such polarization as a function of the applied temperature differential one can verify this situation.

It is to be noted that our early research had shown that the thermoelectric EMF could, under certain circumstances, be greatly affected by the application of a magnetic field to the thermocouple junctions. Accordingly, the tests aimed at sensing thermoelectrically-generated magnetic field effects had a particular significance. Furthermore, we had some interest in the Nernst Effect by which a temperature gradient in a metal in the x direction, with a magnetic polarizing field applied in the y direction can develop electric field action in the mutually orthogonal z direction.

It has become, therefore, a subject of research interest to examine how a bimetallic interface subjected to a transverse magnetic field and a temperature gradient in the interface direction affects the circulation of thermoelectric current between the metals.

What we have discovered that is of great importance to the development of the solid-state thermoelectric refrigerator is that the setting up of a temperature gradient in the bimetallic interface plane between two contiguous metal films will produce a magnetizing field which readily saturates the metal if ferromagnetic. Thus the nickel film in the prototypes tested becomes strongly magnetized in one or other direction according to the direction of the temperature gradient.

When this magnetic field is considered in the context of the Nernst Effect it is seen that it can lead to a transversely directed EMF governed by the product of the temperature

gradient and the strength of the magnetic polarizing field. This transversely directed EMF then contributes a bias active in the individual metal and, being in the same transverse direction, supplements or offsets the Peltier EMF in the prototype implementations.

Remembering then that the heating and cooling actions in the operation of the prototype devices are governed by current flow in metal which is, adjacent the respective heat sinks, in line with or opposed to the action of an EMF, one can see how something new has appeared on the technology scene of thermoelectricity. By using heat to generate current circulation, which in turn generates a magnetic field to provide ferromagnetic polarization, a powerful Nernst EMF set up **in the metal** can act as a catalyst in supplementing the junction Peltier heat transfer action associated with EMF across a metal interface.

This may well be the action which accounts for the very high thermoelectric conversion efficiency we have measured.

In order to quantify this as it may apply to the prototypes we have built, note that a 400 angstrom thickness of well-magnetized nickel subjected to a temperature drop of 20°C across a metal length of 2.5 mm, implies a Nernst EMF of the order of 6 mV across the 0.04 micron nickel thickness.

Though small, this is significant alongside the Peltier EMF across a junction, but the really important point is that this Nernst EMF **is set up in the metal** and not across a metal junction interface. In that metal, owing to the free-electron diamagnetic reaction currents within the nickel and around its boundary, which offset in some measure the atomic spin-polarization of the ferromagnet, there is then scope for some very unusual thermodynamic feedback effects. Those diamagnetic reaction currents which are themselves powered by the thermal energy of the electrons have a strength related to the magnetic polarization and so exceed, by far, the thermoelectric current flowing across junction interfaces. The heating and cooling processes transfer power between the heat sinks in proportion to current times voltage and the in-metal action within the nickel could therefore generate very significant thermal feedback, thereby greatly enhancing the efficiency well beyond that of the normal thermoelectric bimetallic junctions.

This action only results where one of the metals is ferromagnetic and the configuration of the device is such that an applied temperature gradient promotes internal circulation of thermoelectric current around a closed circuit able to develop a magnetic field in the nickel directed transversely with respect to the temperature gradient.

Conclusions

The exciting prospect for future development of refrigeration techniques centres on the possibility that the feedback process can be greatly enhanced by using thicker metal films. It is hoped, therefore, that the research reported here will soon advance to probe the limits of efficiency that are possible with this new solid-state refrigeration technology.

In this connection the truly exciting prospect arises from the possibility that the efficiency barrier set by the Carnot criterion can be penetrated.

To understand this, note that the Peltier EMF on the hot side of a thermocouple is proportional to the higher temperature T' and that at the cooler side is proportional to the lower temperature T . For a given current circulation the heat energy extracted is proportional to T and the net input of electrical power is proportional to $T'-T$.

This is the reason why the coefficient of performance has a Carnot limit of $T/(T'-T)$.

Now, if there is a thermal feedback action that is regulated by a Nernst EMF and we can contrive to assure that the forward transfer of heat arises from a uniform temperature gradient in the ferromagnetic metal, then the Nernst EMF is the same on both sides and the amount of heating on the hot side is, in theory, exactly equal to the amount of cooling on the other side.

There is conservation of energy with negligible net energy input but heat transfer from the cold to hot heat sinks and this implies a very high coefficient of performance not temperature-limited according to the Carnot requirement.

This, therefore, is the challenging possibility that looms in sight and is heralded by the rather fortuitous discovery of the surprisingly high performance characteristics of the Strachan-Aspden base metal thermoelectric power converter.

The Strachan-Aspden device uses what the inventors see as conventional physics, albeit with the innovation of combining transverse A.C. excitation with D.C. thermocouple excitation. However, it does seem that in some curious way the device happens to have features which bring some new physics to bear. By producing a thermally-driven current crossing a strong magnetic field in metal the Lorentz forces on that current develop a transverse reaction EMF in that metal. The combination of that transverse Nernst EMF with a circulating current confined within the metal can, it seems, operate to transfer heat thermodynamically, working through the underlying ferromagnetic induction coupling in the metal. This is somewhat analogous to the way heat energy is somehow diverted into electricity in being routed between the hot and cold heat sinks in a conventional Peltier thermocouple circuit. It does, however, introduce new physics to the technology of refrigeration and offers great promise.

References

- Aspden, H.; Strachan, J. S., **European Patent Application** No. 0369670, 1990.
 Aspden, H., **SAE Technical Paper Series** No. 929474 1992.
 Aspden, H., **Electronics World**, July 1992, pp. 540-542.

APPENDIX III

**The Strachan-Aspden Invention: Operating Principles
[October 1989 Report]**

The object of this Report is to merge a review of the status of the project at the time the primary research was abandoned in 1990 with an evaluation of the design options for taking the project forward. Appendix III, together with IV and V, comprise extracts taken from an earlier Report dated 23rd October 1989 and prepared when the project was most active. These provide background information.

INTRODUCTION

Imagine a panel fitted like a sheet of glass into a window frame but serving as a silent solid-state heat engine which uses electricity to cool the room in summer and heat the room in winter with the high efficiency of a heat pump. Imagine the same panel fitted into a glazed enclosure designed to trap atmospheric radiation to develop a temperature difference across the inner and outer surfaces of the panel and using the trapped heat to produce electricity.

The Strachan-Aspden invention provides the technology needed to fabricate such a panel and brings with it a quite interesting challenge. This challenge is a design problem. The task is that of deciding between a mode of construction that has been tested in prototype form or one that needs some research in advance of development but should prove superior from a commercial viewpoint. The task is to scale down an internal operating voltage and increase internal current flow coupled with conversion to a pulsed d.c. mode of operation rather than having a resonant circuit sustaining a.c. oscillations through the dielectric of a capacitor.

The R & D activity had just begun to address this problem when the Scottish small-business entrepreneurs who undertook initial development deserted the project as their other business ventures failed. This has meant that an invention which could make a major contribution in the effort to free the world from polluting energy technology became virtually dormant.

The merit of the invention can be judged from one simple technical fact. Operating from a room temperature source of heat and melting ice the tested prototype device was able

to generate electricity at close to the Carnot efficiency limit by a technology utilizing the thermoelectric power of base metals **at a rating equivalent to 20 kw electrical power output per kg of metal in circuit**. In a non-developed hand-fabricated form, the device performed at 73% of Carnot efficiency. This is not optimum performance and is far from exploiting the full design potential.

The invention opens up a wholly new field of technological opportunity. It arises from a major scientific breakthrough which involves a totally unexpected discovery. In original conception the invention aimed to use the properties of a dielectric film as a barrier to heat loss by thermal conduction and the bimetallic coating on the film as a thermocouple circuit to convert heat into electricity. In reality it was discovered that the transverse oscillatory current excitation of a thermoelectric circuit produced an astounding effect on the thermoelectric power of the base metal combination.

1989 RESEARCH PROGRESS REPORT

[This section is copied from the 23rd October 1989 report]

"The plan during 1989 was for Strachan to engage in detailed research and onward development of the technology involved with a view to consolidating the patent position by year end.

The research phase has not been without its traumas, essentially for two reasons. Firstly, there was a set-back in that to perform certain tests on the prototype device aimed at measuring efficiency at an elevated temperature it had to be detached from its heat base. Secondly, in attempting this using a chemical solvent to separate two parts, the chemical found its way into the main structure which, lacking in foresight on this possibility, had not been sealed against such contamination. This upset its operation; it was a lesson learned, but at that stage a set-back to the development plan. It was not then possible, without rebuilding, to really get the full measure of the performance properties needed to comply with the initial programme. The question at issue was one of controlling temperature differential on a sustained basis with measured heat throughput rather than monitoring a small piece of ice as it melted by sucking heat from the environment, some of which was being intercepted to produce electricity in transit through the device.

Even before this set-back many experiments on components were performed to test operative features in isolation, with the early recognition that something totally unexpected was involved. A very substantial increase in thermoelectric EMF per junction, far in excess of reference data indication, had been achieved thanks to the particular operating technique adopted in the prototype. However, in spite of these progressive steps, the onward development necessitated a firm measure of the minimal operating efficiency of the basic

device and, though the eventual products will be far easier to assemble, a small panel was made which closely conformed in design with the original but included certain modifications excluding what by then had come to be regarded as possibly non-essential features. This was a gamble, especially as the construction was very intricate and time-consuming when done by hand, with ongoing circuit tests during assembly to assure proper current distribution and uniformity of response. However, in the event, the device, once completed, did perform with equal or better results than the original version.

Happily, in confirming the new design assumptions made during the first months of 1989, the tests on this second device proved to be a major step forward and justified the filing of a third patent application in September 1989.

The second set-back proved how wise it was to have held back on early publication. The onward research investigations showed that what had been a primary design feature intended to block heat loss and so improve efficiency was not directly effective in that role, at least in the way we intended. Indeed, a fortuitous discovery had been made by proceeding on that assumption and the phenomenon involved had had the same effect, but not for the reason first believed. Instead of physically obstructing heat flow through the device, as had been intended, the operative technique actually converted almost all the heat into electricity before it reached the point of no return and so allowed very little to cross by thermal conduction and so escape as waste.

It was only after this discovery was made and an understanding reached concerning the process involved that it became possible to begin to consider disclosing to the scientific community, not just what had been achieved, but why it works so well.

This disclosure is being made now that the initial applications for foreign patent rights have been registered and the purpose is expressly to attract interest from those who have the resources to help in the development of this new energy technology. It is only by such shared action on an equitable commercial basis that the benefits of the Strachan-Aspden invention can make their full contribution in helping to reduce the world's energy pollution, whilst conserving the chemical qualities of fossil fuel resources for future generations."

The above text, quoted from the 23rd October 1989 report was prepared as a confidential document. The sponsors used the report to try to attract investment in their overall business interests and shortly thereafter ceased to fund R & D on this invention. Apart from initial costs of overseas patent applications, the funding that had been provided had been mainly that needed as salary by Scott Strachan whilst involving him as a consultant on other projects. As yet, therefore, this important energy invention has not had the benefit of serious development funding.

The research effort up to October 1989 had concentrated on simplifying the assembly of a prototype test device using the bimetallic coated film which could also serve as a capacitor dielectric. The immediate objective was to measure the heat-to-electricity energy conversion efficiency and explore the design criteria involved. The inventors were, however, mindful that the principles of operation of the device did not really depend upon capacitative operation and the current limitation which that implied. It was deemed possible to extend the technology to structures which involved an all-metal through-circuit for electrical power and some plans were made for building such all-metal structures for bench testing. Had the research been active in 1990 this alternative would have been thoroughly tested so that a choice could have been made as to the best mode of implementation in a production assembly.

It is noted that no formal product design proposal, with costing that could be used in a business plan, was drawn up in the 1989 period. Strachan was engaged on the preliminary functional testing to assess the performance and determine the optimum techniques and choice of materials. Without this information, one could not price either the market value of a product or its manufacturing cost. Even now, product costing is not really possible until the through-metal-circuit R & D investigations have been completed. The fact that a 20 kw rate of electrical power generation can be delivered by 1 kg of metal, drawing on a temperature differential of 20° C, is the best indicator that it must be possible to build an operational unit that can be costed low enough to justify a very large sales volume. The real question now concerns the best configuration of the metal used and the best choice of metals.

THE STRACHAN-ASPDEN INVENTION

[The section in quotes is copied from the 23rd October 1989 report]

The following is a technical description of the principles underlying the Strachan-Aspden invention written on the assumption that it would form the basis of a lecture by Harold Aspden to an audience who would later witness a demonstration of the operational device by Scott Strachan.

"Before outlining the technical nature of our invention there is one very significant point that I think is worth registering at the outset. The test device on which our company was founded used the thermoelectric properties of contact between two base metals, aluminium and nickel, to produce electrical power from a low grade heat source. A temperature difference of 20 degrees relative to room temperature was sufficient to produce a steady power output of one fifth of a watt per cubic millimeter of metal in the thermocouple circuit. Scaled up, that is 20 kw per kg of metal. It did this with an efficiency that was well

above 50% of Carnot efficiency for this temperature range. This is as good as internal combustion engine performance where the fuel burns at more than 2,000 degrees.

This is an invention which should have been made 50 years ago as part of the solution of the electronic age. As to the patentable merits of the invention, it has been said that even a simple invention can be judged highly if 'a long felt want' is satisfied. No one can deny that we need a breakthrough in the pollution-free energy field and what I have to disclose is not quite so simple.

The device is essentially a flat panel that can be fitted like a window or used as a heat exchange interface in an engineered installation to convert heat energy into electricity or to use electricity to cool one face of the panel and heat the other face.

It is simply a panel with an electric supply lead. All that there is between the two faces of the panel is a laminar structure of metal with some insulation, together with a small electrical transformer and an electronic control unit connected to the supply lead via a switch.

What is special, however, and what causes this device to be a revolutionary breakthrough in energy technology, is governed by a combination of two special features. These we have called:

- (1) DYNAMIC EXCITATION FEATURE
- (2) TRANSVERSE COMMUTATION FEATURE

There is also a third feature which has been used in the prototypes to enhance efficiency even further, but which will only be used in very special products. This is termed:

- (3) THIN FILM ENHANCEMENT

Basically, we are talking about a thermoelectric system using either the Seebeck Effect or its converse, the Peltier Effect. By connecting different metals in an electrical circuit and positioning the respective junctions on the hot or cold side of the panel, the passage of D.C. current is related to the thermodynamic effects. Energy can be converted in this way, as is well known, but not, until now, with an efficiency that has such overwhelming implications in the field of energy technology.

The thermocouple working in Seebeck mode operates to extract heat from one junction and inject heat at the other junction. The balance of energy is electrical in the sense that an EMF or voltage is set up at the cooled junction and this can deliver output power in the electrical circuit, provided it is smaller than the back EMF or reverse voltage at the heated junction.

In efficiency terms, the operation is governed by the fact that the heat absorbed or produced at a junction is proportional to the junction temperature measured on the absolute scale, that is referenced on -273 degrees centigrade. Therefore, if one junction is at -3 degrees centigrade (270 K) and the other at 27 degrees centigrade (300 K), we can produce 300 units of electricity from the cooling effect at the hot junction but have to give back 270 units of electricity by heating the cold junction. The net gain is electricity, in theory, could be 30 units of electricity for the price of a 270 unit throughput or 300 unit input of heat energy for these low temperature conditions. These high numbers of heat energy units should not be regarded as energy waste. They relate to what is called 'enthalpy', which is a measure of heat content referenced on 273 degrees centigrade below zero and even ice has an enormous heat content on this basis of reference.

What has just been described is the so-called Carnot efficiency. It is 10% for the 30 degree temperature differential considered. It works either way, in the sense that if electricity is supplied rather than produced, the input of 30 units of electricity can cause a transfer of 270 units of heat from the outside temperature source at -3 degrees and heat a room to 27 degrees. This is the Peltier mode of operation and it provides a tenfold gain on the use of the electricity in an electric heater, assuming full Carnot efficiency. Operating at 50% of Carnot efficiency, a 10 degree heating can be achieved with only 7% of the power needed by an electric convector or radiator.

The reason we do not see such Peltier heat pumps used on a large scale for domestic heating or power generation purposes is, very simply, that it has not been possible to achieve an adequate level of performance relative to the Carnot limit.

Technically, the obstacle has been the need to find materials which can be used to form thermoelectric junctions having a high Peltier coefficient. This is the factor relating the power conversion at a junction with the amount of current passing through. It is measured in millivolts at room temperature. The dilemma facing this technology is that if base metals such as copper, iron, aluminium etc are used to form junctions, the EMFs involved are very small. However, the electrical conductivity is good and this helps to reduce losses. Unfortunately, in such metals good electrical conductivity goes hand in hand with good thermal conductivity and then we lose heat by leakage through the metal circuit between the hot and cold junctions. For base metals this has been seen as a 'no win' situation, because efficiencies of the order of 1% of Carnot efficiency are representative of practical performance.

For these reasons, the attentions of the last half-century have concentrated on special metals, alloys, and semi-metals or semi-conductors. The price paid for accepting poor electrical conductivity of perhaps one thousandth that of copper has been rewarded by a much reduced thermal conductivity and a very much increased thermoelectric power. The EMF involved is typically in excess of 200 microvolts per degree with a Peltier coefficient

of 60 millivolts at room temperature. Such devices are useful for special applications, where small current throughput and low efficiency are of no consequence, but their general use as Peltier heat pumps or electric power generators has been limited.

A typical state-of-the-art power generator using junction materials formed from alloys of bismuth, tellurium, selenium and antimony has a design specification that recognizes a maximum operating efficiency of 22% of Carnot when operating with a high temperature differential of 300 degrees using a source at 600 K. The electric power produced, assuming perfect accord with the design specification, is of the order of 0.1 kw per kg of metal used to form the thermoelectric junctions.

Practical applications depend upon the energy throughput rate as well as efficiency and what is being offered by the Strachan-Aspden technique is so far ahead of state-of-art technology on both these counts that one must wonder how the technology could have gone so far adrift in missing the real potential of the Seebeck effect.

Some words from the book 'Direct Energy Conversion' by Professor Stanley Angrist bear upon this:

"At the time of Seebeck's work, the only devices available for producing electric current were extremely weak electrostatic generators. Fifty years passed before steam engines drove electromagnetic generators. It was, undoubtedly, electromagnetism that caused succeeding generations of physicists and engineers to lose interest in the curious effects of thermo-electricity. The only widespread use of the effect was in the measurement of temperatures by means of thermocouples. It is difficult to say how the history of electrical engineering and electronics would have developed had Seebeck's discovery been widely employed."

Those researching this field today seem to have been attracted by the empirical discovery of new materials and have gone astray in not researching the basic question why metal junctions have such low thermoelectric power. This is very curious, bearing in mind that classical thermodynamics theory tells us that the theoretical power of base metal combinations is of the same order as that of these special materials.

I must admit, however, that though, with hindsight, we can bring this problem into focus, we did discover the solution only when we were performing diagnostic tests on our principal prototype. In short, we had built something that worked too well and we were wondering why.

The point rests on the question of whether the metal used increases in electrical conductivity or decreases in conductivity as temperature increases over the operating range. In base metals conductivity decreases with increase in temperature. This means that at the

cooled junction the decrease in temperature improves conductivity. Now, if the electric current flowing through the junction is uniformly distributed this will simply mean that the junction has a uniform cooling across its interface. However, if, as occurs in electrical discharges in gases, the flow tends to be in short-lived filamentary surges, there is the real possibility that a current could develop a non-uniform pattern of cooling. A current flow concentrated at one position would form a 'cold spot' in the junction interface. The electrical conductivity there would increase and so the current would favour that path of least resistance and become locked on the cold spot. This could drive the temperature so low that the effective temperature governing Carnot efficiency is not what we see from the external actions.

In other words, owing to the increase in electrical conductivity with drop in temperature, the thermoelectric power falls far below the theoretical potential of the metal junction. There is therefore an enormous loss of efficiency when base metals are used in thermocouples in what has been conventional technology.

Why does this not affect the special materials as well? The answer is that such materials do not have the same temperature characteristics. The p-type alloy bismuth-telluride (25%) with antimony-telluride (75%), and n-type alloy bismuth-telluride (75%) with bismuth selenide (25%) have, for example, electrical conductivities which reduce the temperature if operated above 300°C. Such a temperature characteristic means that cold spots cannot form. Therefore, if we want to use base metals, with high energy throughput, the only way we can hope to get high efficiency is by somehow preventing the cold spots from forming in these materials. This is exactly what we achieve by the DYNAMIC EXCITATION FEATURE. Its effect is to increase the thermoelectric power of an aluminium-nickel couple from 17 microvolts per degree to a value well in excess of 300 microvolts per degree. Since this factor operates as a squared effect, because it drives proportionally more current and puts proportionally more voltage behind it, the electric power becomes hundreds of times greater than expected on conventional design criteria. This, therefore, is a major advance because it allows us to use basic metals with high capacity for delivering current, rather than expensive compositions with very limited energy throughput capacity.

What is the DYNAMIC EXCITATION FEATURE? In simple terms, this is a technique by which, instead of causing a steady D.C. current flow through the junctions, we interrupt the flow several thousand times per second in such a way that the current flow through the cooled junction relocates rapidly and before the non-uniform temperature or cold spot condition can develop.

The advantage is that we get the kind of thermoelectric power (i.e. voltage) from aluminium-nickel junctions that is available from bismuth-telluride, but, for comparable dimensions, the higher electrical conductivity of the base metal device allows more than one

hundred times as much active power (wattage) to pass through. This takes us well forward technologically, but the TRANSVERSE COMMUTATION FEATURE which will now be described advances performance even further, so far in fact that we can trim back our design objectives on efficiency to simplify the manufacture and so reduce the cost of this technology.

The conventional design of a thermoelectric device involves having two distinct junctions between the two metals, one junction being at a higher temperature than the other. The metal between the junctions merely serves as a conduit for electric current and, unfortunately, provides a channel for heat loss by thermal conduction from the hot to the cold junction. Rather than trying to develop special materials which facilitate flow of electric current but obstruct heat flow, we followed another route. We also had in mind that a really good commercial device could hardly take in heat and produce electricity if the materials were not good conductors of heat. After all, the heat has to get into the device before it can be deployed into electrical form.

Our device uses two metal layers which interface over the whole distance from the hot side to the cold side. We then set up a thermoelectric current which it drives around the closed circuit formed by the interfacing metal layers. We accept the full measure of heat conduction through the metal by allowing it to travel through the full length of the metal layers. However, note that the route taken by the heat is never further away from a junction interface than the thickness of a metal layer. This means that the heat has repeated opportunity to be effective in generating electric power as it progresses along the junction interface. This is a feature vital to success. Unlike the conventional themopile where, once clear of the hot junction, the heat travels to the cold junction to be dissipated, we ensure that it has repeated 'bites of the cherry', as it were, en route to that destination, with the effect that very little even reaches the point midway where the current flow reverses. By 'reversal' is meant flow from metal B to metal A, whereas initially it was flowing from metal A to metal B.

This feature has a remarkable effect on efficiency because virtually all the heat supplied is converted into electricity. The \$64,000 question, however, is how we intercept the electrical energy flow around the closed loop circuit formed by the two contacting metal layers and so gain access to that electricity before it is all dumped back into heat over the interface area where the thermoelectric current flow reverses.

This is where the 'transverse' excitation aspect of our invention holds the key to a successful energy converter. As can be seen from Fig. 1, we stack bimetallic layer upon bimetallic layer to build a stack between a hot surface and a cold surface and the external current flow involves a transverse current flow through the whole stack.

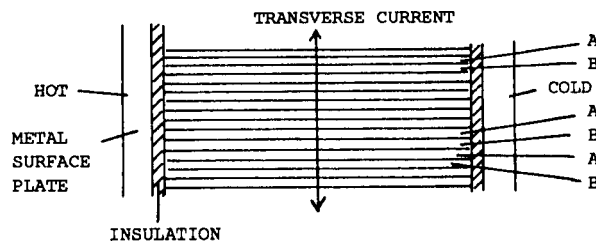

Fig. 1

The point then to keep in mind is that at the interface between the two metals forming each layer there is a thermodynamic effect causing a voltage to act from metal A towards metal B and this voltage varies across the layer according to the local temperature. It is greater, the higher the temperature. Because of this there is an imbalance of voltage from point to point in the heat flow direction across the contact interface in each layer when a temperature differential exists between the side faces of the stack. This imbalance causes current circulation in the sense shown in Fig. 2, where one layer is presented in enlarged form.

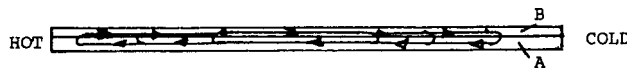

Fig. 2

All this does is to cool one side and heat the other, with the result that the metal conducts heat from the hot side to the cold side.

However, now suppose that we provide a channel for transverse current flow up or down the stack. This means current flows transverse to heat flow but, in this layered arrangement, it augments or opposes the thermoelectric current as it traverses a junction, depending upon the direction of flow of the transverse current. The channel for this transverse current is assured if there is good interface contact between all metal layers in a stack formed by metals A, B, A, B, A, B etc in sequence. Owing to the symmetry of the system a current travelling right in metal B will have to overcome the same potential barrier or back EMF at the cold junction whether it goes up or down the stack. However, we cannot have some contributing to transverse current flow by going up the stack in one part and elsewhere having some going down the stack. Either the current all goes up or all goes down or there is no transverse current flow at all and the thermoelectric current flow is everywhere confined to its own bimetallic layer.

The current will take the path of least resistance, or will it? If there is an external resistive load connected in the transverse current flow path, then the easier route for current will be the closed circuital track shown in Fig. 2. Some small amount of current should flow either up or down the stack, because the external circuit offers a supplementary route for

current. However, this will not give us scope for causing cyclic interruption of the primary junction current, nor will it give access to any real power output. Indeed, without the dynamic excitation, the voltage driving the circuital current in Fig. 2 is very low. Nevertheless, the circuit is a bistable system and how it behaves when relying solely on the thermoelectric voltage produced by the heat input is not the same as its response when a voltage surge up or down the stack governs the action.

Given a trigger effect which causes a transverse current surge up or down the stack, the junction current can be interrupted by a fast cycling switch in the external circuit and, once this happens, the full high powered thermoelectric action comes into effect, but this is a condition only effective if the transverse current is strong enough to exceed the normal steady state junction current. Given some intrinsic inductance or capacitance to sustain transverse voltages which carry the action through the zero current transient states, the device can become locked into the dynamic excitation mode to deliver an electrical current powered by the full thermoelectric action. In this mode the current flow is represented by the snaking flow shown in Fig. 3.

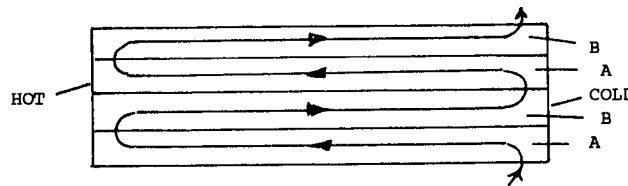

Fig. 3

The device actually works and exhibits extremely high efficiency in converting heat energy into electrical power output. Indeed, the capacitive versions of the device which have been constructed use bimetallic layers less than 0.1 micron in thickness (one micron is a millionth of a meter) and 300 such layers of one square cm area interleaved with 28 micron thick dielectric could generate 300 milliwatts of electrical power using just over one calorie per second of heat input at 40 degrees Centigrade and output at 20 degrees.

This is quite remarkable, bearing in mind that even these temperatures and their differentials are so low. It is even more remarkable when one realises that the power generated is at a rate in excess of 20 kilowatts per kilogram of metal used to form the thermoelectric circuits. This capacitive device does, however, make use of the enhanced electrical conductivity of thin films, which accounts for the very high efficiency obtained.

To bring the design parameters into perspective it is useful to consider a formula for the figure of merit Z normally applied to thermoelectric systems. This is presented in Fig. 4.

$$Z = \beta \alpha^2 \sigma \gamma / K$$

FIGURE OF MERIT Z TRANSVERSE COMMUTATION FACTOR β
 THERMOELECTRIC POWER (VOLTS/DEGREE) α SPECIFIC ELECTRICAL CONDUCTIVITY (MHO-CM) σ
 THIN FILM ENHANCEMENT FACTOR γ THERMAL CONDUCTIVITY (WATT-CM) K

Fig. 4

This formula, when multiplied by the operating temperature, in absolute degrees Kelvin (say, 300 at room temperature) is a measure of the potential electric power generated as a ratio of the heat conducted from the hot junction to the cold junction and so wasted. This assumes operation with a low temperature differential and allowance has to be made for the duality of the metal paths, which are in parallel for heat flow and in series for electrical current flow. This tends to reduce the ratio by a factor of 4. Also, the potential electric power output depends upon the load resistance as related to the internal resistance of the device.

All in all, therefore, to build a viable thermoelectric power converter the Seebeck coefficient α has to be as high as possible. The Strachan-Aspden devices tested so far are offering α values in excess of 300 microvolts per degree centigrade using base metals for which the bulk specific electrical conductivity σ is in excess of 100,000 mho-cm and the specific thermal conductivity about 2 watt-cm. On these figures, at the temperature of 300K, the formula gives near unity ratio of electrical power to thermal power lost.

However, the Strachan-Aspden technique earns its qualities by virtue of the factor β and also the factor γ . These are the coefficients representing the effects of the transverse commutation feature and the thin film feature, respectively. Each of these factors is a unit of magnitude giving ten-fold benefit.

The electrical conductivity of a thin film of a few hundredths of a micron thickness can be more than 10 times greater than the bulk value. Such film was used in the main prototypes tested. We did not measure the factor γ , because the bimetallic thin film material was available commercially with a rated electrical resistivity of 0.1 ohm per square. It comprised thin film layers of aluminium of 0.02 micron thickness and nickel of 0.04 micron thickness. Knowing the bulk values of σ as given by reference books, the value of γ was estimated as being about 10 from these data.

Concerning the factor β , this represents the repeated 'bites at the cherry' effect as heat gets repeated opportunity to convert into electricity as it is conducted into the device. For conventional thermocouples where the temperature drop between junctions is linear, β is

unity. However, we had a system in which the temperature was changing much as depicted in Fig. 5.

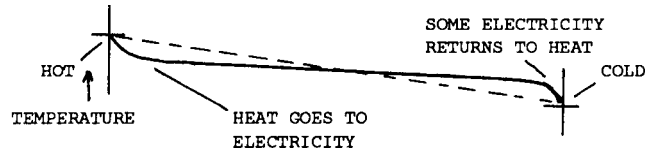

Fig. 5

The dotted line represents the linear temperature profile and the curve the profile we are exploiting. β is a measure of the conventional temperature gradient of the dotted line as a ratio to the minimal temperature gradient midway between the junctions. The latter is a measure of the heat energy going to waste and the much larger gradient of the full curve at the hot junction is a measure of the heat energy entering the device before conversion into electricity. Because the midway gradient is much lower than the linear case, we have a high β factor and because it is very much lower than the input temperature gradient we have a very efficient device capable of taking in far more heat than a conventional device.

I believe that I have said enough to outline why the Strachan-Aspden thermoelectric power converter works so well. The ongoing research relates to how far we can compromise on the thin film factor γ with a view to using thick metal layers and relying exclusively on the β factor of the transverse commutation feature. Unquestionably, our primary products will use the dynamic excitation feature to get the advantages of power from base metals, but we foresee also the use of special metals as well, coupled with designs based on the β factor.

I should like to end by describing how, even before we filed our first patent application or got involved commercially, we got a measure of the β factor applicable to our first demonstration device. Very simply, we had built a small panel having metal faces and layers of thin metal film running from face to face but embedded in an insulating dielectric. Looked at in the direction of heat flow, the metal and dielectric were side-by-side, with the metal presenting a cross-section amounting to about one five hundredth of that of the insulator. Such a device, therefore, was not, in thermal conductivity terms, a through-metal conductor.

To get a measure of its properties, we put an ice cube of standard size on the upper metal face and attached the lower face to a commercial heat sink base at room temperature. The ice melted, partly by heat absorbed by air convection from above, partly by heat loss by thermal conduction through the intervening insulation and partly by heat conduction through the metal. It took in excess of 20 minutes to melt completely. This was with the output leads from the device unconnected, that is, on open circuit. I knew from a test at home that such an ice cube on a metal work surface took about 5 minutes to melt and took 30 minutes on a Formica-topped kitchen table. The point of interest then was that when the

same sized ice cube was used on the device with the output leads connected to an electric motor or a resistor load, the time of melting reduced to between 3 and 5 minutes. The motor stopped running, of course, soon after the ice had completely melted, but the message from these very simple measurements was clear testimony of a very high internal efficiency in the generation of electricity from heat. There being no independent electrical power supplied to the device and the ice being the only perturbing influence, the connection of the electrical load had diverted more than 80% of the heat energy around the wired load circuit and this was via a capacitance. That 80% and more of power was electrical power and most of the other 20% of heat conduction was seemingly unnecessary loss because much of it was due to extraneous convection or heat conduction through what was unnecessarily thick dielectric insulation.

It was from such a very simple test that we knew the β factor had to be 10 or more, but we were carried along by that empirical performance and, may I say, that was so high that, for a time until we could make more precise measurements, mainly of temperature, we thought we had achieved the impossible, by going above 100% of Carnot efficiency.

As it is today, in our best performing thin film prototypes we still have difficulty measuring just how close we are to the ultimate Carnot efficiency.

Concerning thick film designs, which do not have the high thin film conductivity feature, our research is progressing in sustaining the thermoelectric voltages achieved by the DYNAMIC EXCITATION FEATURE and exploiting the β gain by the use of the TRANSVERSE COMMUTATION FEATURE."

Concerning the latter comment about thick films, this was a theme which this author (H. Aspden) urged at the time (October 1989), but this was shortly before the R & D funding ceased and the test facilities closed when the other business interests of the sponsors failed.

This author did, independently, seek to experiment with a small test unit in which thin nickel plates plated on both sides with copper were bonded into an integral assembly for resistance testing. It did not function as hoped when subjected to a small temperature differential.

However, this was a first attempt at a time when thoughts were on the collapsing sponsorship and it later became evident that the test external circuit facility used lacked the necessary current capacity to cope with current oscillations at the requisite frequency and strength.

The test apparatus used was also unable to sustain a significant temperature gradient in the metal owing to metal thickness being too large and it had, at the time not occurred to this author that it would have been better to drive a moderate current oscillation through the structure and look for a cooling effect attributable to the Nernst action.

Evenso, in this latter regard, the nickel sheet material used in these experiments would, with its copper plating, have posed the same problem that has now (1994) been encountered in a much larger test device, namely the fact that a multiple bimetallic interface in a series circuit can, without an initial temperature gradient to prime the action, avoid the Thomson Effect current diversion and thereby generate junction heating that is not segregated from the Peltier cooling.

The author's current research which will be described in Energy Science Report No. 3 is now directed along a track which aims to overcome these particular problems in an effort to avoid transverse current excitation through a dielectric medium whilst constraining heat flow to be transverse to the current and EMF attributable to the Nernst Effect.

APPENDIX IV

**The Strachan-Aspden Invention: Test Results
[October 1989 Report]**

This report is a copy of the TEST REPORT presenting the status of the Strachan-Aspden Energy Converter project on 19th October 1989, as included in the 23rd October 1989 document.

Introduction

The device tested was built expressly to verify design criteria, essentially to check that we were right in eliminating certain design features present in the first demonstration device. The tests confirm our theoretical assumptions.

In order not to alter too much in this stage of development, the same commercial bimetallic coated dielectric was used and the same physical dimensions of the thermocouple junction interfaces. These are not optimum, particularly concerning thickness of metal layers and possibly concerning choice of the actual metal combination as well as the length dimension between the thermal surfaces.

However, whereas the operating frequency was 500 kHz with the first device, the present device runs at 18 - 25 kHz, depending upon load and voltage output rating. Such frequencies impose design constraints, which will not be a problem if we can build a non-capacitative device now predicted as a possibility using the verified design principles.

The primary objective of the tests reported here is not to see whether the efficiency of the device assures its commercial viability as it stands, because we can certainly design to achieve a far better power rating and a simplified technique of fabrication. The objective is to measure the efficiency of the device for operation over a moderate range of ambient temperature, with atmospheric, geothermal and waste heat in mind as energy sources.

The measure of efficiency and study of factors affecting efficiency are vital to projecting commercial applications and designing products for manufacture, especially concerning the Peltier mode for refrigeration and cooling and also for conjecturing products which store electrical energy as heat and regenerate electricity. The use of plastic film as a substrate for the bimetallic layers has limited the temperature range of the particular device

tested. Also, owing to the specific form of the electronic switch system built for the device, tests in the refrigeration (Peltier) mode did not prove viable for reasons in no way related to the device structure and measurements of efficiency of Peltier mode operation have been deferred.

An overall performance figure, allowing for all circuit losses and output voltage transformation, which can be relied upon for conversion of heat to electricity with temperature differentials as low as 10 to 30 degrees Centigrade is 70% of Carnot efficiency.

The Structure of the Test Device

The device is constructed from 300 layers of 28 micron thick high dielectric constant plastic film as a substrate for sputtered junctions of two layers of metal, nickel and aluminium. Each layer had a width of 3 cm and a length of 0.25 cm, the width dimension and edge forming the surface interfacing with the heat exchange surfaces. The aluminium film was 0.02 micron thick and the nickel film 0.04 micron thick.

These 300 layers therefore defined 300 junctions each having exposure to a hot and a cold face of the panel form of the assembled device. These were divided into 20 groups of 15, each group comprising 3 sub-groups of 5 layers. Each such sub-group is bounded by a layer of copper as an electrode for wiring the device into the chosen series/parallel configuration. Thus, in effect, there were 15 layers stacked to form a series capacitor unit and 20 such units were wired together to form a parallel connection of the capacitor units, ultimately having connection to an external circuit by two supply wires.

The copper electrodes were narrower than the junction length to reduce their thermal conduction contribution to the heat path. The entire stack of 300 junction layers was bonded on to a ceramic powder composition base to give good heat coupling but to ensure electrical insulation from the heat sink base an upper aluminium sheet was bonded by an electrical insulating heat sink compound to the upper surface of the stack to form the other external heat surface.

When a temperature differential is set up between these external heat surfaces there is a thermoelectric charging of each junction which contributes to the energy storage in the capacitor stack. Indeed, as a function of the temperature differential, the capacitor so formed has a greater effective capacitance than would be expected purely from calculation based on the dielectric constant and dimensions of the assembly. Typically, the capacitance can be of the order of 1.5 microfarad for this very compact assembly.

The thermoelectric current acts to sustain the recharging of the stack as it is systematically charged and discharged by a fast operating switch unit. For the test to be

described this unit comprised five electronically controlled switches operating in parallel expressly to ensure that there is a minimal loss of electric potential, inasmuch as the EMF of a mere 15 junctions was being switched. The control of this switch bank involved a frequency generator input of negligible power. Note that it was a specific feature of the first prototype test device that it included a self-activated oscillator for switch control powered by the electric signal generated by the device.

The action involved, therefore, can be seen as one involving deploying thermoelectric power into the charging of the capacitor stack and then, as fast as possible having regard to the recharging speed, transferring the stored energy to an output circuit by a cyclic switching operation. Subject to the capacitive delays and charge storage aspects, the action can also be seen as one involving circulating thermoelectric currents in the bimetallic layers with a superimposed transverse current flow through the capacitor.

A high Q transformer winding is intermittently connected to the stack via the switches. This presents a low impedance into which the capacitor stack drops its thermoelectrically acquired charge. The secondary winding of the transformer then transforms the resulting voltage to a value which matches well with the load, both to give suitable measurement voltages and also to ensure that the load seen by the stack has a sufficiently low impedance to draw out the charge quickly. Note that the device has its own internal resistance and the load resistance has to draw most of the power.

Measurement Criteria

The device tested is a flat square metal-faced unit which has a pair of electrical input/output leads. Given a temperature differential across its metal faces an electrical power output is available. In terms of the heat input, this electrical output depends (a) upon the internal design structure of the device (which cannot be varied as part of the test) and (b) upon the manner in which the load circuit is electronically controlled. The latter control, though as just described working successively to charge and discharge the capacitor form of the device, also implements what we term 'dynamic current excitation' and this greatly enhances the power output. The A.C. power supplied is converted to D.C. and smoothed for measurement. The performance depends upon matching the load with the device to secure optimum output.

Basically the test to be reported is very simple. By feeding in a sustained amount of heat, controlled by electrically powering a small resistor in a liquid heat bath, the task is to reconvert some of that heat back into electricity as D.C. in an output load at a steady voltage and current. This will give basis for precision tests on power in and power out, but to assess the result obtained it is important to have a very good measure of the temperatures of the two metal faces. The temperature measurement poses problems, because, firstly, we must beware

of any non-uniformity of temperature across the operative surfaces and, secondly, we must know the extent, if any, of any interference caused by the measuring device or probe.

Earlier test results had been clouded by the problem that the bounding 1 mm thick aluminium plate was not able to buffer the heat distribution to assure a uniform temperature, given a concentrated heat source (electrically energized carbon resistors) on the external face.

For this reason the initial measurements on the device described, which were unreliable in ranging from 50% to 100% of Carnot efficiency, according to test conditions, have been repeated using a stainless steel can containing water heated internally by a chain of four 10 ohm resistors. This can was specially built with a flat lower surface able to interface well with the heat surface of the device and was mounted thereon using heat conducting paste. Also, the whole structure was housed in a close fitting heat insulating container.

The temperature measurements involved calibrated platinum resistance probes registered by a digital voltmeter and were from time to time confirmed with an alcohol thermometer.

Peripheral Test Information

It was not part of the test reported here to repeat certain experiments that were made in the earlier development stages. Nor could we measure directly the thermoelectric EMFs in the sections of the stack built into the device. During construction it was part of the discipline of the assembly procedure to test each part-assembly of five junction layers to verify insulation and be sure that it was performing with the power of 2 millivolts per degree Centigrade when subjected to dynamic excitation. Any that did not match the uniformity requirements were rejected. However, as will be seen, the test data do tell us that this thermoelectric EMF is at work in the operating device because the output EMF from a stack is measured and the voltage at the output terminals is roughly equal to the internally produced thermoelectric EMF times the measured efficiency relative to the Carnot limit. This also means that the current output as a measure of junction current relates by this total thermal power to the potentials active at the junctions and so gives a measure of the thermoelectric power in the device.

This thermoelectric power is the crucial factor in our onward design of any products. It was 400 microvolts per degree Centigrade per junction pair in the above device and this applied to the thin film (0.02 micron aluminium on 0.04 micron nickel) assembly. The two metals had no intervening metal; they were vapour deposited. In contrast, earlier tests had shown that a stack of metal plates of iron and nickel of sub-millimeter thickness with

soldered junctions gave a thermoelectric power per junction of 118 microvolts per degree centigrade with dynamic current excitation. Given that we can reasonably expect iron and aluminium to present similar thermoelectric action when forming junctions with nickel, the question we need to resolve is whether that gap between 118 microvolts and 400 microvolts is due to the thin film aspect in the vapour deposited case or the adverse effect of the intermediate solder in the thick film test case.

The most important test data of interest, therefore, at this time and before products are designed and manufacture evaluated, are

- (a) the actual efficiency for limited ambient temperature use of the device already constructed, and
- (b) the thermoelectric power of a thick metal junction assembly with no solder connections.

This report addresses the first of these issues and the next report will deal with our findings on the other question.

The onward test programme must relate to the factors such as optimum film thickness and dielectric thickness in the vapour-deposited/capacitor system or thickness of a thick film version, optimum electronic design and excitation frequency as well as waveform profiles, choice of metals, structural dimensions (panel thickness) and electrical insulation/heat conducting spacing material at the interface of the external metal surfaces and the junction assembly.

The Test Data

These tests were performed independently by Scott Strachan and Harold Aspden during different periods in October 1989.

The Strachan tests were performed between 10th October and 12th October. The test results obtained by Aspden on 17th and 18th are those listed in Tables II and IV.

The test apparatus is as shown in Fig. 1.

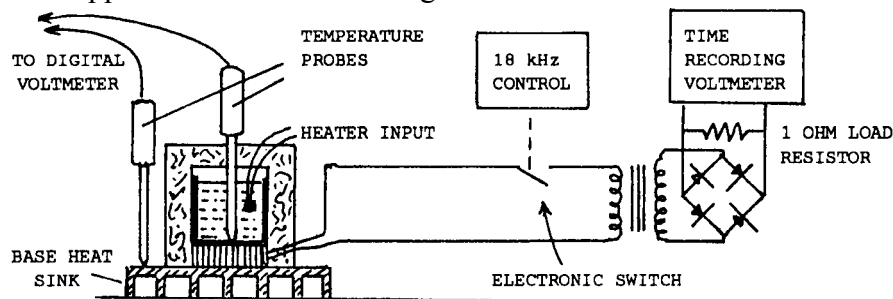

Fig. 1

Application of heat energy is via the medium of heated (or cooled) water in a container on the upper heat exchange surface and use of a commercial heat sink base at room temperature replicated conditions which would apply to production devices. The cold underside can be considered to be at an even temperature because it is mounted on a massive heat sink with a recognized high heat dissipation capacity.

The water heat sink provided a uniform temperature interface and this temperature was measured by a commercial platinum resistance temperature probe calibrated to give a measure of temperature via a digital voltmeter. A similar and separate heat probe was used to measure the temperature on the surface of the base heat sink.

Owing to heat transfer through the device, albeit mainly via the electrical conversion route, as Peltier cooling occurs at one face and Peltier heating at the other, it is inevitable that the actual temperatures at the working interfaces of the device will be slightly lower than the hot temperature measured and slightly hotter than the cold temperature measured. This means that the true efficiency relative to Carnot will be just a little greater than that calculated using the measured temperatures. No allowance is made for this in the test data, because the temperature drops involved would be present in an engineered installation and so the test results give an overall measure of effective efficiency which can be regarded as representative of commercial conditions.

Preliminary Tests

The following tests were conducted under steady-state conditions, that is, the rate of heat input was pre-set and temperature readings as well as electrical power output readings were made only after the system had stabilized.

TABLE I

TEST No.	HEAT INPUT			OUTPUT TO 1 OHM		TEMPERATURE EFF.		
	Volts	Amps	Watts	Volts	Watts	T'	T	%
1	6.64	0.179	1.19	0.125	0.016	33.8	20.0	30
2	9.16	0.244	2.23	0.280	0.079	40.4	20.6	56
3	11.22	0.298	3.34	0.450	0.202	47.5	20.8	73
4	12.60	0.337	4.25	0.520	0.270	53.4	21.0	64
5	19.00	0.530	10.07	0.720	0.518	62.2	23.0	44

The above readings were the first set of readings to be made on the device under proper laboratory test conditions using electronic test circuitry that was designed to operate

essentially with power output voltage above 0.3 volts, which is a nominal threshold for effective operation of the germanium diodes used to rectify an A.C. output. For this reason, attention centres on tests No. 3 and 4. Concerning test No. 5, this fell short in measuring true efficiency for reasons to be discussed below, owing to a heat dissipation problem which set in above 55 degrees Centigrade and upset the measurement on the input side.

Immediately, however, one can verify the design assumptions by considering the ideal 100% of Carnot condition if applied to test No. 3. This would require all the heat energy input at the hot side to convert to electric power given by $N\pi i$, Where N is the number of junctions (300), π is the Peltier coefficient $\alpha\theta$ and θ is the temperature of the hot junction in Kelvin (320). With α as 400 microvolts per degree, this gives an input power of (38.4)i watts. Now, i is the junction current and we regard this also as external current, subject to allowance for the series/parallel junction combination and the transformer ratio. In effect, therefore, the 100% of Carnot situation can only occur if the heat power supplied at 320K is precisely such that it is 3.34 watts, which corresponds to a junction current of 87 milliamps. This flows in each of 20 parallel circuits to suggest a total current of 1.74 amps would suffice to carry all the heat input through as electricity.

This checks with the measured current of 0.450 amps if allowance is made for the 5:1 transformer ratio. In fact, this measure is 2.25 amps compared with 1.74 amps needed for 100% efficiency and this is 77% agreement (cf. the 73% of Carnot efficiency measured). This is very good agreement, also bearing in mind that the 400 $\mu\text{V}/\text{K}$ thermoelectric power can be effectively diminished by parasitic current flow owing to the 20 parallel-connected circuits in the device and may need some offset for the partial action of the component added by the Thomson effect. The latter does not contribute to the Peltier heating and cooling at the junction proper, but does drive current as part of the thermoelectric power.

The measurements of current output in relation to heat input fit remarkably well and confirm the high thermoelectric power, α of 400 $\mu\text{V}/\text{K}$, that had been measured on a test basis as each five-junction part-assembly was built into the device.

It had been foreseen from theory that about 260 $\mu\text{V}/\text{K}$ would be true thermoelectric power and about 170 $\mu\text{V}/\text{K}$ could be due to Thomson effect. Therefore, a 60-70% efficiency factor might imply a measured output voltage of the order of 250 $\mu\text{V}/\text{K}$. In test No. 3 the 0.450 volts came from a 26.7 degree differential and 15 junctions in series with a 5:1 transformer ratio. This works out as a junction EMF of 225 $\mu\text{V}/\text{K}$.

Concerning the drop of efficiency as more heat is fed into the device (test No. 5) it is found that the apparatus begins to lose heat from evaporation as bubbles form around the heater. This loss of heat is such that the apparent performance drops appreciably with increasing temperature. However, this is an artefact of the way in which the heat input is measured by the electrical heating of water. Evaporation on the input side of the device

cannot be a fair factor in the test, which is only viable provided bubbles are not formed in the test heat input source or the latent heat carried away by those bubbles is somehow accounted for.

Load resistance versus internal resistance

The value of the load resistance, given a variable heat input rate, is an important consideration. The heat input determines the operating temperature and this, in its turn, determines the output EMF. The load resistor and this EMF determine the current output, but for optimum operation it is necessary for this current output to be the full junction current. It is possible for some junction current to be internally diverted by closed loop circulation between the metals forming a bimetallic layer. Such circulation would transfer energy from the hot to the cold junctions without the Carnot component being diverted for use in the external load circuit. However, the test bears out an assumption which emerged in the development of the 'cold spot' theory of the device. The expectation from this was that, at least when operating in the Seebeck mode under test, the dynamic current excitation developing the enhanced thermoelectric power would drive the junction current exclusively through the external circuit. On this basis, the only load matching consideration is how the internal resistance of the device relates to the load resistance in contributing to ohmic losses.

For the 1 ohm load condition of test No. 3 we can interpret the output of 0.450 volts as a measure of 0.090 volts on the input side of the 5:1 transformer. This is the output of 15 junction pairs and, for the temperature differential of 26.7 degrees, it implies that a thermoelectric power of 225 $\mu\text{V/K}$ has reached the load circuit. Bearing in mind that a 400 $\mu\text{V/K}$ thermoelectric power is known to be potentially active and that the 1 ohm load is a 0.04 ohm load on the input side of the transformer (owing to the squared effect of the 5:1 transformer ratio), this suggests that the internal load resistance is 0.03 ohms if there is no loss of potential. A value of 0.02 ohms is calculated from knowledge of the resistance of the commercial material used to build the device (see comment on this which follows) and this is probably the true value. Such resistance applies if virtually all the external current is flowing by snaking action through the thermoelectric junctions with very little internal closed loop flow detracting from that performance. These considerations tend to confirm the design assumptions used.

The internal ohmic heat loss is then estimated from the measured external current 0.450 amps, which scales to 2.25 amps for the input side of the transformer and this current in 0.02 ohms implies an ohmic heat loss of 0.10 watts.

This can be reconciled with the 0.202 watt output with an estimated 70% of Carnot efficiency, much as is deduced for test No. 3, especially as some of the ohmic heating at 0.10 watts is available for regeneration of electricity.

This discussion really aims to assess the scope for increasing efficiency further by future design which reduces internal resistance, it being important to understand the factors affecting performance in the design under test.

It now remains to reconcile the relatively low efficiency of test No. 1, for example, with that of test No. 3. This is easily explained simply because the germanium diodes used in the bridge rectifier connected to the transformer output absorb energy, becoming good conductors only as the forward voltage across them rises above 0.3 volts. This will present no problem in production thermo-electric devices because many more junctions than 15 will be connected in series and this will result in high performance relative to the Carnot limit, even with the low temperature differentials represented by test No. 1.

However, in the verifying tests to be reported below, this will be checked in view of the importance of applications working with quite low temperature differentials.

Calculation of internal resistance

The efficiency necessarily depends upon the internal resistance of the device. This may be calculated approximately using the fact that the 0.1 ohm per square specification of the bimetallic layer arises from parallel flow through 0.2 ohm per square of nickel and 0.2 ohm per square of aluminium. The device involves series flow through 300 bimetallic layers of width 3 cm and length 0.25 cm, but the current will not follow the longest route. This is somewhat less than 0.03 ohms per layer. The layers were connected 15 in series and 20 in parallel and this implies a total internal resistance somewhat less than 0.75 times 0.03 ohms or, say, 0.02 ohms. This is the value estimated from the measurement data reported above.

Verification Tests

These tests were performed by H. Aspden on 17th and 18th October. The first set of tests reported in Table II concentrated on the peak range of efficiency indicated by Table I. It was found that even a small change of heat input rate meant waiting for between 20 and 30 minutes to secure temperature equilibrium. The latter is vital to proper measurement of temperature. The temperature readings are believed to be correct to within 0.05 degrees Centigrade and, as far as can be judged, any error from making measurement at a surface point slightly offset from the actual operative thermal interfaces would mean that the efficiency values obtained are 'worst case'. It is, therefore, felt that the efficiencies now registered are reliable in indicating what can be achieved in a commercial installation.

TABLE II

TEST No.	HEAT INPUT			OUTPUT TO 1 OHM		TEMPERATURE EFF.		
	Volts	Amps	Watts	Volts	Watts	T'	T	%

6	9.50	0.253	2.40	0.300	0.090	41.9	18.6	51
7	10.00	0.266	2.66	0.340	0.116	42.8	18.8	57
8	10.50	0.279	2.93	0.375	0.141	45.1	19.3	59
9	12.00	0.318	3.82	0.490	0.240	49.4	20.2	69
10	13.00	0.345	4.48	0.545	0.297	54.0	20.6	65
11	14.00	0.371	5.19	0.565	0.320	55.0	20.9	59

These tests reported in Tables I and II are characterized by the use of electrically heated water as the thermal input source, as opposed to an electrically heated metal interface. The object was to get more uniformity of temperature and so a precise indication of the true temperature. However, above 55 degrees Centigrade the water loses heat rapidly owing to vaporization and then the measure of heat input rate fails to indicate true efficiency.

The tests certainly reveal that efficiency of heat to electricity conversion of 70% of the Carnot level is a reasonable expectation with temperature differentials in the 30-40 degree range close to ambient conditions, but this is further supported by the tests in Table IV.

Based on test No. 10 a check was made of the effect of changing the dynamic excitation frequency. The operating frequency for the data in Tables I and II was 18 kHz. This had been chosen for optimum tuning of the circuits. As might be expected, there was a drop off in efficiency with reduction of frequency. The data given in Table III apply.

TABLE III

TEST No.	FREQ. kHz	THERMAL INPUT Watts	POWER OUTPUT Volts Watts	TEMPERATURES T' T	EFF. %
10	18	4.48	0.545 0.297	54.0 20.6	65
11	14	4.48	0.530 0.281	54.0 20.6	61
12	10	4.48	0.495 0.245	54.0 20.6	53

This test does not mean that the frequency has to be of the order of 18 kHz to obtain the highest efficiencies from the dynamic excitation. It is just that the capacitor structure of the particular test device with its transformer inductance and self-inductance has an optimum switching frequency. A problem ahead is to assess the best frequency for dynamic excitation giving the highest thermoelectric EMFs and then design the device so that the capacitance and inductance match this operating frequency.

The next set of experiments involved a change in the transformer from the one used in the above tests which had a 5:1 ratio to a new one with an 8.5:1 ratio. This required a 25 kHz excitation frequency for best response, owing to the change in inductance on the primary side.

The object of this change was to explore the loss of output power for very low temperature differentials, which loss resulted from a threshold cut-off in the germanium diode bridge rectifier circuit used to produce smoothed D.C. from the transformer output. The problem faced was due to the A.C. output waveform being of the form shown in Fig. 2. As the signal amplitude increases, more and more of the signal rises above the operating threshold of the diodes and, to get a realistic efficiency measure, substantially all of the signal has to lie above the threshold.

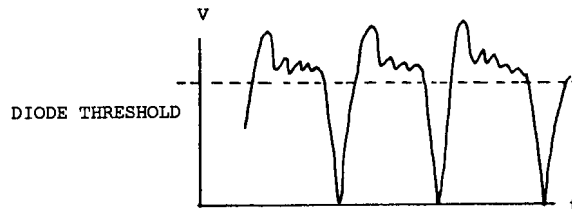

Fig. 2

The sole purpose of the following tests in Table IV was to check to be 100% sure that we still have an efficient converter using the temperature differentials of Test No. 1. This test has given 30% of Carnot efficiency with a 13.8 degree differential but the output voltage was below the diode threshold for a significant part of the dynamic excitation cycle. By stepping

TABLE IV

TEST No.	HEAT INPUT			OUTPUT TO 2 OHM		TEMPERATURE		EFF. %
	Volts	Amps	Watts	Volts	Watts	T'	T	
13	8.48	0.226	1.92	0.400	0.080	38.3	18.8	66
14	6.20	0.168	1.04	0.255	0.032	32.8	18.8	67

the voltage output up by the greater transformer ratio, a greater portion of the signal becomes effective in overcoming the bias in the diodes.

These data clearly show that the comparable results for tests Nos. 1 and 2 suffer from the diode cut-off, that the problem has been easily overcome by output circuit redesign and

that efficiencies of 66% plus relative to the Carnot level are to be expected as the operating norm of the Strachan-Aspden converter, even when the temperature differential is only a few degrees.

Tests using iced water

It was possible to cool the heat sink base by immersion in a tray of iced water and hold the upper heat surface of the device at ambient temperature. The results (power output for a given temperature differential) were fully in accord with the performance just reported for similar small temperature differentials. The ice test of the first prototype device holds up in that electricity can be produced by melting ice. Such tests, however, do not give a measure of efficiency because the rate at which the ice is melting is difficult to measure. However, the efficiency must be as indicated in the tests of this report, because the device and its circuit only 'see' temperatures at the working heat surfaces.

Conclusions

The tests reported above are definitive tests on a Strachan-Aspden device using thin film thermoelectric techniques with dynamic excitation and transverse commutation in a capacitative assembly.

The tests aimed at determining efficiency. The efficiency results were typically 65-70% of Carnot level for differentials of temperature in the ambient range. The power rating measured in heat throughput rate was 2 kilowatts per square meter for a 20 degree temperature differential. The corresponding electric power generation with this very low temperature differential is 80 watts per square meter. However, efficiency, rather than throughput power, was the purpose of these tests and it is important to remember that the working metal involved in the test device is interfacing over only one part in 1000 of the total area of the heat input surface. As we adjust the metal film thickness relative to the dielectric and conceivably eliminate the dielectric, the full design potential can be exploited. It is such that the technology of the device can cope with any practical level of heat input per unit area that available heat sources (or heat transfer materials) can supply at the operating temperatures specified.

Concerning tests in Peltier mode, meaning input of electricity to cause heat transfer between the heat surfaces, this was not possible with the specific design of excitation control circuitry of the device just tested. The first prototype incorporated a self-tuning circuit which could adjust to give the best dynamic switching rate.

Such tests will be performed but until they have been performed either on the subject device or other implementations we cannot pronounce on the efficiency for Peltier mode operation. Our feeling is that it will be high, but perhaps not as high as for electrical power generation in Seebeck mode. However, high efficiency is more important for electrical

power generation applications and an outlook of 70% of Carnot with more expected from production designs is very good indeed.

Footnote

Much of the research effort between February 1989 and July 1989 involved efforts to fully understand the relative roles of the factors which contributed to the working of the first prototype. It was a set back that an attempt at partial reassembly of that device to test efficiency had caused its destruction by internal shorting owing to chemical penetration. However, the new device, built in July-August 1989 period and modified according to the results of that research, now verify the design assumptions and have yielded the efficiency data. Thick-metal-film test converters are now under construction and once the tests on these are complete we will be in a position to project how best to proceed to a product stage.

Our patent position has been brought into line with these recent findings so that our main international cover will relate directly to design variations centred on the structure incorporated in the test device discussed in this report. Such cover also caters for what is expected to be a successful outcome on the thick-film embodiments.

H. Aspden: 22nd October 1989

The above test report describes the status of a research test at a time when the interest centred on measurement of efficiency. In the diagnostic research phase which followed it was realised that there was a gain in performance that came from the Thomson effect driving current along the thin film by heat action. One did not need to generate electricity to sustain the full measure of current flowing and thereby eat into some of the useful power generated.

The problem, however, with the capacitive device was that the transverse current carried through the capacitor stack which was powered directly by the Peltier EMF was no doubt a distributed current across the section of the stack. In this case the capacitor implementation must involve joule heating owing to some current flow in the thin section of the metal film, as allowed for in the above analysis.

However, then the current traversing the junctions in the transverse direction is not concentrated at the edges of the bimetallic layers, as it could be in a modified non-capacitive implementation. The actual efficiency of the capacitor device found under these circumstances is quite remarkable and is at the limit of the what is conceivable from Peltier action owing to the temperature profile across the junction interface. Bear in mind that the temperature governing the Peltier action is not exclusively that at the

edges. This suggests that there is some other action involved in the device which contributes to enhancing the efficiency.

Research into this question points to a thermal feedback effect connected either with the Nernst Effect or with free electron diamagnetism, meaning a thermodynamically powered gyromagnetic reaction set up in conduction electrons in metals in opposition to the magnetizing effect arising from the Thomson effect circulating currents in the metal films.

The updating of this research report will therefore need to examine the theoretical factors involved and the very different design considerations which apply if one makes connection between the bimetallic films by metal conductive edge contact only, without the circuit path being through charge oscillations in a capacitor dielectric. Such a report update also may need to include an examination of the research implications if one designs the converter to over-excite the thermal feedback action, assuming that such an action is really adding to that efficiency. In principle these later developments point to a very much greater performance potential, having regard to the fact that we are exploiting temperature gradients in metal with transverse current excitation and not a power current flow through metal directly between junctions at different temperatures.

APPENDIX V

**The Stachan-Aspden Invention: Thermodynamic Power Anomaly
[October 1989 Report]**

D.C. THERMOELECTRIC POWER ANOMALY

The Strachan-Aspden invention shows that thermoelectric EMFs far greater than are expected from conventional textbook data are effective with A.C. operation. The reason for this needs to be understood in order to give one a measure of confidence in advancing the R & D effort needed to exploit this newly-discovered phenomenon.

The following scientific paper, which has not been published elsewhere, deals with this question.

ABSTRACT

The discrepancy between the theoretical and measured thermoelectric power of bimetallic thermocouples is explained on the assumption that current flow across the junction occurs in filamentary surges which concentrate the heating and cooling effects and so distort the effective temperature differential. The basic theory used conforms with that of more classical treatments, inasmuch as modern theory has adapted to cope with semiconductor materials which exhibit temperature effects quite different from those found in base metals.

The theoretical thermodynamic value of the Peltier coefficient is shown by Ehrenberg [1] to be:

$$\left(\frac{kT}{e}\right)\log\left(\frac{n'}{n}\right) \quad (2)$$

where k is Boltzmann's constant, T is the junction temperature, e is the electron charge and n', n are the population densities of the free electrons in the two metals forming the junction.

The thermoelectric power of an individual junction is the same expression without the T term, being an EMF per degree of temperature.

In Table III of this Ehrenberg text [1] a tabulation shows the measured values of the thermoelectric power for various base metals referenced on the metal sodium. The data show that the discrepancy between the calculated and measured values is a factor of 15 for Ag and Au, a factor of 21 for Cu, 51 for Al and 6 for Ni. Ehrenberg also deduces theoretical values for the Thomson coefficient, which makes an additional contribution to the thermoelectric effect and is a function of the rate of change of free electron density with temperature. Ehrenberg does not compare theory and experiment in this case.

In view of the potential benefits of efficient thermocouple devices in refrigeration avoiding the use of polluting CFC chemicals, there is now a pressing need to understand the fundamental reason for this discrepancy. The following investigation is part of an ongoing commercial research study into this problem, which has already revealed techniques by which to close the gap between the calculated and measured thermoelectric power, particularly for an Al-Ni thermocouple.

Equation (4) is derived on the thermodynamic assumption of a thermal pressure balance as between electrons in both metals. If, as with certain semiconductor thermocouple junctions, there are positive (p) and negative (n) charge carriers in the different conductors, the Peltier coefficient need not depend upon the ratio of carrier densities. If p-n annihilation occurs at one junction and p-n creation at the other, the current-related thermodynamic energy exchange is more consistent with a thermoelectric power corresponding to a Peltier coefficient of $3kT/e$. Upon annihilation, for example, two carriers merge, each transferring its individual thermal energy $3kT/2$ into electrical power, and so developing a net EMF E related to an energy E_e equated to $3kT$.

For the Al-Ni combination, using equation (4), Ehrenberg [1] assumed a carrier density ratio of 21, which gives a logarithmic factor of 3.04. This implied a thermoelectric power of 265 microvolts per degree centigrade. Since then, however, carrier polarity data for the Hall effect, as revised, suggests that the Al-Ni thermocouple may have a thermoelectric power related to the p-n condition, which coincidentally gives virtually the same value. Thus, the very substantial discrepancies between observation and theory noted by Ehrenberg still apply, even for this Al-Ni metal combination.

It is possible that, though a predominant free electron population exists in a metal conductor, the electrical conduction properties are not, at every instant, related to the shared action of all the electrons. Imagine, for example, that the charges carrying current tend to concentrate their ordered motion collectively into a transiently relocating filamentary in-line flow through the conductor. This filament, which may comprise short and transiently discontinuous current elements, corresponding to charge concentrations, breaks up to be

replaced by another such filament elsewhere so that, on average over a period of time, the flow appears uniformly distributed across the section of the conductor. In a sense, this physical picture is easy to justify because the electrons following at speed in the same direction along a common line, one behind the other, are less likely to be scattered by collisions.

Of course, such speculation has little value unless supported by tangible evidence. Force-free vortex filaments which appear on a nanosecond time scale feature in plasma research [2] and have led to analysis of the density and velocity distribution profiles of electrons and positrons in filaments [3]. However, so far as solid conductors are concerned, this filamentary action is not something that can easily be established. It may emerge from research into the properties of 'warm' superconductors or from research on the thermoelectric anomalies under discussion.

Firstly, with the plasma aspect in mind, it is known that the arc discharge in mercury arc rectifiers develops discrete cathode spots on the surface of the mercury pool. This means that the current divides into separate flows. These spots meander around but there is some mechanism by which the discharge breaks into discrete filaments of the order of 15-20 A in strength, as if this represents some critical current factor defining a single current filament.

Secondly, extensive researches by Hildebrandt [4,5] have shown that current as high as 30-40 A will divide between two separate anode-cathode discharge paths, with anti-phase modulation at a period of 15 ns, and that this effect is not caused by resonant circuit properties but is an inherent property of the conductive medium. Thus, in a plasma at least, this is consistent with a preferred filamentary current state in which the carrier flow is involved in what may be termed an 'inverse avalanche effect' as the conduction action concentrates into fewer carriers in a filament with a 15-20 A critical maximum current for continuous in-line flow.

It is now noted, without particular elaboration, that if a train of electrons form in line at equal spacing and move together to convey current along that line, then, if each one steps forward to the position of the electron ahead at the Compton electron frequency, the current carried is 19.79 A. This is simply ec/λ_c , where e is electron charge in coulombs, c is the speed of light and λ_c is the Compton wavelength.

This is such a basic physical quantity that we must indeed be very attentive to any scientific phenomenon which happens to point to a 20 A current threshold. It suggests a limiting value for the amount of current which can flow in a single filament. It suggests that current may be conveyed even through metal conductors in a burst mode in which it involves short filamentary current elements having a 20 A intensity over lengths reduced as necessary in proportion to the average current flowing through the metal.

More important, however, is the fact that such a current with electrons really in line at spacings as close as their classical diameters would imply a velocity of electron motion in the current direction of the order of the Fermi velocity of an electron gas. We assume this is possible, notwithstanding the classical Coulomb repulsion effects, embracing to some extent the idea that what is involved is electron displacement from electrically-neutral sites, as if electrons alternate with positive holes or as if electrons and positrons moving in opposite direction somehow carry the current. This proposition then suggests that a Fermi velocity, which is not a function of temperature, in some way powers the action. For a given metal this means that the electron speed along a filament is constant and that filaments of lower current strength than 20 A either comprise electrons or holes at proportionally greater spacing or what are, effectively, short discontinuous filamentary components. Possibly, filamentary vortex loops of circuital current may form, occasionally opening up to carry current forward through the conductor before reforming as closed loops.

Conceivably, therefore, even in a metal containing a high free electron density, the current flow might, at any instant, be carried by but a few of these electrons and even, given a relatively few mobile carriers, allow the positive 'holes' to make a current contribution by favouring a flow route which causes some ordering and displacement of the holes to set up current filaments nucleated by positive charge carriers.

Now consider such a current filament as traversing a bimetallic junction interface in a thermocouple. The Peltier heating or cooling will be concentrated in an extremely small spot defined by the zone taken up by the filament. Thus the temperature of that spot, which determines the Peltier coefficient cannot be the mean temperature we measure for the junction interface as a whole. Depending upon the relaxation time needed to cause the filament to relocate, the effective temperature active in determining thermoelectric power can be very different from that assumed.

A concentrated cooling effect at a spot in a junction interface must increase the electrical conductivity in the region of the spot and this alone could develop a crossing point of least resistance, which would tend to keep the current trapped in that position. An exception to this can be expected in certain semiconductors and alloys over temperature ranges for which resistivity may decrease with increase in temperature. Indeed, such materials tend to be those used in advanced thermocouple research, which itself implies that here lies the weakness of normal metals from the viewpoint of their application to thermocouples.

The Peltier coefficient is measured by supplying a controlled amount of heat to a junction cooled by the Peltier effect, based on a technique developed by Calendar [6]. For Peltier cooling the governing equation is easily formulated as:

$$\frac{\delta\theta}{\delta x} = \frac{\alpha\theta'i}{4\pi Kx^2} \quad (3)$$

This merely represents the gradient of temperature θ with spherical symmetry with respect to distance x from the point of action, given that K is the heat conductivity (assumed the same for both metals). α is the thermoelectric power (volts/°C), θ' is the absolute temperature and i is the mean current.

When solved this gives:

$$\theta = \theta_0 - \alpha\theta'i/4\pi Kx \quad (4)$$

The minus sign would be replaced by a plus sign if the current direction corresponded to Peltier heating.

We define a mean least value of x as x_0 and, for ease of rough calculation, estimate this as the distance from the centre to the side of a square area of a cross section of filament. Thus, assuming N electrons per unit length of filament with n as the electron density:

$$n = N/(2x_0)^2 \quad (5)$$

We further equate the energy of self inductance of the filament with the kinetic energy of the electrons, so that:

$$\frac{1}{2}Li^2 = (N)\left(\frac{1}{2}mv^2\right) \quad (6)$$

where L is the standard calculable inductance 0.5×10^{-7} henries per metre, m is electron mass 9.1×10^{-31} kg and v is electron speed. From (7) and (8):

$$i/x_0 = v\sqrt{(2nm/L)} \quad (7)$$

The temperature difference between the mean junction temperature θ_0 and the temperature θ' is then $\alpha\theta'/4\pi Kx_0$ and, putting this in (5) gives:

$$\delta\theta/\delta x = (x_0/x^2)(\theta_0 \& \theta') \quad (8)$$

The actual temperature effective at the junction, and the mean junction temperature, change and so scale in proportion. indeed, from (6):

$$\theta'(1 - \alpha i/4\pi Kx_0) = \theta_0 \quad (9)$$

From (9) this becomes:

$$\theta_0/\theta' = 1 - \alpha(v/4\pi K)\sqrt{2nm/L} \quad (10)$$

This means that this expression represents the factor by which the measured thermoelectric power or Peltier coefficient will underestimate the true value which really governs the thermodynamic action.

It is believed that v is independent of temperature, as already stated, and that it is also independent of current strength, inasmuch as N is the variable corresponding to effective current. We may use Fermi-Dirac statistics to estimate v , but the result is much the same if we appeal intuitively to the threshold current condition $I = ec/\lambda_c$ and estimate v as given by equation (8) when N is $2.66 \cdot 10^{14}$ per metre. This corresponds to a line of electrons spaced by their classical diameter, as calculated using the formula of J. J. Thomson, a saturation condition that is relevant because the diameter was calculated by J. J. Thomson by equating kinetic energy with electromagnetic energy in the magnetic field.

It is found from this that v is 284 km/s. To estimate the factor (6) insert typical values for copper, eg. $n = 1.3 \cdot 10^{29}/m^3$ and $K = 400$ watts- $m/^\circ C$ to find that the factor becomes:

$$1 - 0.12\alpha \quad (11)$$

if α is expressed in microvolts per degree C.

Writing now the measured thermoelectric power as ϵ , we know that the factor just deduced is α/ϵ , so that if α is 144, as calculated by Ehrenberg for copper at 17° C, the measured value of ϵ which we 'think' is a measured value of α does, from (13), work out at 7.9. Somewhat similar results apply to Ag and Au, which have smaller n value and so a similar theoretical α value, but much the same K value. Note that equation (13) based on n being 60% that of copper and α being 100, say, gives ϵ as 9.7.

Ehrenberg gives, for Ag, Cu and Au, experimental values of ϵ that range from 6.9 to 7.2 microvolts per degree C, whereas the theoretical values range from 99 to 144 per degree C. This, therefore, is fairly well in line with the interpretation offered here.

Considering aluminium, for which α referenced on sodium, in theory, is 183, n is greater than for copper by the factor 1.6, K is measured as 210, and ϵ as measured is 3.6 in the same units. The same argument leads, via equation (12)) to an equation (10) factor $1 + 0.29\alpha$ or a theoretical ϵ value of 3.4.

Thus, even for aluminium, for which the thermoelectric power discrepancy between textbook theory and experiment is a factor of 51, we see that the interpretation provided here reduces the discrepancy to a point where theory and experiment are virtually in full accord.

It is submitted that the filamentary current proposition discussed is highly relevant to thermoelectric action. As intimated above, commercial research aimed at reducing and, indeed, virtually eliminating the discrepancy in practical thermocouple circuits is proving successful. The secret is to use a.c. to prevent cold spots from forming and so choking off the thermoelectric power, this being a d.c. current symptom peculiar to metal thermocouples as opposed to semiconductors.

REFERENCES

- [1] W. Ehrenberg, 'Electric Conduction in Semiconductors and Metals' (Clarendon Press, Oxford), pp. 21-23 (1956).
- [2] D. R. Wells, IEEE Trans. Plasma Science, **17**, 270 (1989).
- [3] V. Nardi, Phys. Rev. Lett., **25**, 718 (1970).
- [4] J. Hildebrandt, Physics Letters, **95A**, 365 (1983).
- [5] J. Hildebrandt, J. Phys. D: Appl. Phys., **16**, 1023 (1983).
- [6] H. L. Callendar, Proc. Phys. Soc. Lond., **23**, 1 (1910).

APPENDIX VI

THERMOELECTRIC EXPERIMENTAL DEVICE CONSTRUCTION

The following is a copy of a text written by John Scott Strachan dated February 9, 1994 transmitted to U.S. researchers and project engineers as briefing material for non-confidential discussions held in Edinburgh, Scotland later that month.

It contains details concerning Strachan's fabrication of the original test device of which this author had no prior knowledge and it is evident from this information that there is no easy and immediate route to developing this technology using the methods adopted by Strachan. This will therefore explain why Strachan has switched his attentions to other projects, leaving this author to pursue this thermoelectric research along lines closer to his own original perceptions of the invention which avoid use of PVDF substrate film.

Strachan's account dated February 9, 1994:

The original device discovery happened accidentally and was the result of the construction of an ultrasonic lithotripter. At the time Dr. Aspden and I were discussing the concepts of thermoelectricity and were trying to conceive methods of reducing the thermal wastage in such devices. I had constructed a few experimental samples but with little success. At the same time I was working on an idea for a sonic 'laser', a device to progressively amplify a travelling wavefront in a transducer with a view to creating a high intensity ultrasonic pulse from a low acoustic impedance.

The goal was to produce an intense compression pulse from a low acoustic impedance source for the delivery of a focused shatter pulse in kidney stones. The resultant 'sonic laser' units were to be placed in an array which would allow phase steering of the wavefront and the changing intensity in three dimensions to produce a versatile triptic pattern. This would allow the destruction of stones down to 1 mm in size with very little heating of the surrounding tissue. The further advantage of the low impedance of the source would be the ability of the array to 'listen' to the shattering of the stones and intelligently follow the crack growth with the peak intensity of the wave. Had the project been successful it would have reduced the treatment time for gall and kidney stones by a factor of ten or more and the lithotripter itself would have had a market value of more than \$100,000.

The device consisted of several stacks of high k PVF2 in a column, with an electronic circuit set to trigger a compressive pulse in phase with a pulse travelling through the stack, in order to synchronise the circuit and cope with the variations in acoustic impedance of the

adhesives. I interleaved the PVDF layers with layers of recording tape. Thus, as the compressive wave passed through the stack, the motion of the recording tape could be detected in the next layer as a fluctuating voltage. As such, it could be used to trigger the next pulse in perfect phase, since the speed of the electromagnetic signal allowed advanced warning to the trigger circuit of the approaching acoustic wave.

It was a really neat idea and I was very proud of it!

The device worked well for brief instants but kept blowing the drive circuit. This seemed to occur when the stack was touched on one side. Since I had been thinking about thermoelectric devices and the stack resembled vaguely some of the ideas I had of trying to create a capacitatively-coupled thermopile (later it was proved that such a thing is inherently impossible)*, I wondered if there might be a thermoelectric explanation for the stack's strange behaviour.

The construction of the stack was as follows.

Materials:

- (a) 28 μM PVF2, ($D_{33} = 27$, $k = 18$) having bimetallic coating of Ni and Al (Ni = 2200 angstrom, Al = 800 angstrom) and a resistivity less than 0.1 ohm per square.
- (b) BASF metal recording tape poled manually in line with the long axis.
- (c) ZAP ethyl cyanoacrylate adhesive (formula unknown).
- (d) One strip 2.5 mm x 2.5 mm x thickness resonance 2MHz PZT 5a lead zirconate ceramic with silver electrodes.

* This statement with its brackets is made in the February 9 1994 account by Strachan but the 'impossibility' relates to a thermopile involving only the Peltier Effect because the 'proof' amounts to saying that as much electric charge flows in one direction as in the other and so must cause at least as much heating at either junction as cooling. This has now to be viewed in a different context because the Thomson Effect introduces bias as between the junctions of each thermocouple pair and once the Nernst-Ettinghausen Effect becomes operative, particularly where one or both metals are ferromagnetic. [This footnote by H. Aspden].

- (e) 10 layers of super-hard acrylic machined to a thickness such that the acoustic delay is equal to a half wavelength at the resonant frequency of the ceramic strip. A suitable material is available from Aerotech Laboratories in California.

Unfortunately, I do not have a detailed specification on this as the material I used was part of a free sample sent to Dick Ferren of Pennwalt Corporation.

The sound velocity in PVF2 is 2.2 mm per μ s.

The BASF tape and the PVF2 were then treated with a 2% solution of tetra butyl titanate in petroleum ether to improve bonding. This process must be carried out in an arid atmosphere and then the surfaces should be exposed to a humidity of 100% or greater at a temperature of 40°C. The process is extremely tricky since, if moisture is present before the evaporation of the petroleum ether, the titanium will not bind through the metal layer on to the PVF2 or mylar. This can be diagnosed by the white powdery appearance of the surface. If successful the surface will exhibit a slight iridescence.

Once the petroleum ether evaporates and the iridescence is present the exposure to humid atmosphere takes place. This will sometimes produce a slight trace of the powdery surface but this may be washed off in petroleum ether or toluene. DO NOT USE ISOPROYL ALCOHOL!!!

Cyanoacrylate will not polymerise in the presence of protons, i.e. at any pH below 7 the surface of PVDF will release free protons in the presence of isopropyl alcohol and thus prevent secure bonding. The titanate layer helps to maintain a surface pH above 7 in a moderately dry atmosphere but can not fight the catalysis of the propyl groups in the alcohol.

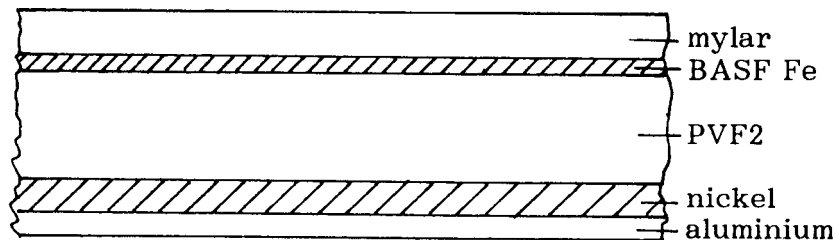

Fig. 1 Layered composition of laminate formed

The greater the care taken at this stage, the more chance of success later. Every single strip should be examined before lamination for any signs of wear on the surface or any trace of white titanate. Failure to do this will virtually guarantee delamination the instant any voltage is applied. This process is time consuming and the several thousand strips will take several weeks to laminate, even working ten to twelve hours a day. But skimping the preparation means that there is no chance of creating any percentage of intact stacks and the entire effort will be entirely wasted. The lamination jig surfaces should be positively charged PTFE. The layers may be added one by one for a period of time equal to one quarter of the

anaerobic cure time of the ethyl cyanacrylate. Then a press is applied at a pressure of between 1 and 6 tonnes whilst an ammonia atmosphere is blown past the stack to catalyse curing. Then the process is continued. Time is the main enemy. Since each layer must be examined and the quarter cure time is typically 30 seconds, this is a very intensely stressful process. I managed to complete only one stack on the first day and had scrapped nearly a thousand layers in the process. Practice improved the situation.

The PVF2 and the BASF tape were laminated together layer by layer to reach a thickness of 0.55 mm, i.e. half λ at 2MHz. This process was repeated until a large number of stacks were produced. Next a 5,000 volt supply was connected across each stack and those that vaporised were discarded. A suitable breathing apparatus should be worn during this process since the fluorine gas emitted as the PVDF breaks down is highly poisonous. It is also corrosive and so the entire process should be carried out at a suitable location and well away from glass, since the hydrofluoric acid will cloud the glass, making you unpopular with your colleagues! The percentage of stacks that break down depends on the defect density of the original PVF2. That percentage depends on whether a gel colloid or suspension process was used during polymerisation. The use of gel tends to leave micro bubbles of gel in the PVF2, reducing the breakdown voltage.

The surface chemistry of a poled polymer is a constant problem since the creation of compound acetates with various metals can occur with very little encouragement. The passing of a current through the cyanacrylate often starts a cascade catalysis which, once started is unstoppable. This is worst with copper where even a few seconds of current will produce a sufficient 'seed' to result in the total acetisation of the metal within a month or so. With nickel the process is less easily turned on since a sulphate must exist before the process starts. The initial test voltage does not usually initiate a corrosion and so the elements may be stored anaerobically and aridly for an indefinite period. Once the elements are subjected to operational voltages or are even accidentally squeezed, which produces enormous voltages in local areas, a gradual decay of metal begins. This will begin in spots surrounding any non-polymerised cyanacrylate. Such spots exist since, even with all the precautions described, certain free H^+ ions will be present preventing polymerisation. This is why such care **MUST** be taken. The metal layers can disappear in just a few hours if the defect density in the bonding layers exceeds 2 per cm^2 . The reduction in decay time is exponentially proportional to defect density.

The remaining stacks were now measured for electrical conductivity and those that showed a resistance of greater than 0.001 ohm from side to side were discarded. The apparatus for measurement of the resistance is designed to cancel the apparatus resistance. The electrodes of the apparatus were a pair of steel slip gauges. This is needed in the ultrasonic device to prevent the waveform from distorting. **In the thermoelectric application this stage-by-stage testing is even more critical since it defines both the electrical and thermal conductivity of the stack.***

Those elements discarded for resistivity reasons were reground on the edges with a fine diamond wheel in liquid nitrogen to improve flatness and were set aside for an attempt at a slightly thinner stack. (As it happened these discards were lost and only found again at the end of last year [1993] when they were used to construct the third thermoelectric demonstration device.)

The original batch was divided into several sets of 50 elements.

Each element was coated with Emmerson and Cumming silver loaded epoxy and bonded to a thin copper or silver strip, top and bottom. Silver is preferable to prevent the production of copper acetate from the cyanoacrylate but I did not have a large quantity of this and by this time was pretty impatient to see if the device would produce the high power ultrasonic pulse I hoped.

Each element was then laminated to a layer of hard acrylic half λ thick as shown in Fig. 2 below.

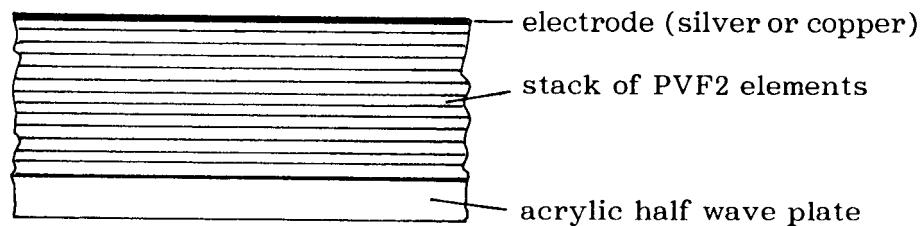

Fig. 2 Composition of bonded element

Emphasis here added by H. Aspden, this being the first reference to the thermoelectric properties and much of the foregoing description having concerned the fabrication of a structure intended to withstand mechanical oscillations at acoustic frequencies. The thermoelectric application requires the nickel and aluminium layers to remain intact and in mutual interface contact and does not require those metals to be as thin and fragile as they were in the process described by Strachan. [This footnote by H. Aspden]. *

These elements were then assembled as shown in Fig. 3, with the ceramic driver at one end.

Each element was then connected by its electrodes to a drive circuit. The ceramic transducer bonded to the end of the stack was connected to be pulsed by a conventional driver. As the wave passed

through the stack an electromagnetic signal from the moving magnets triggered the pulses through the stack in a cascade. By adjusting the

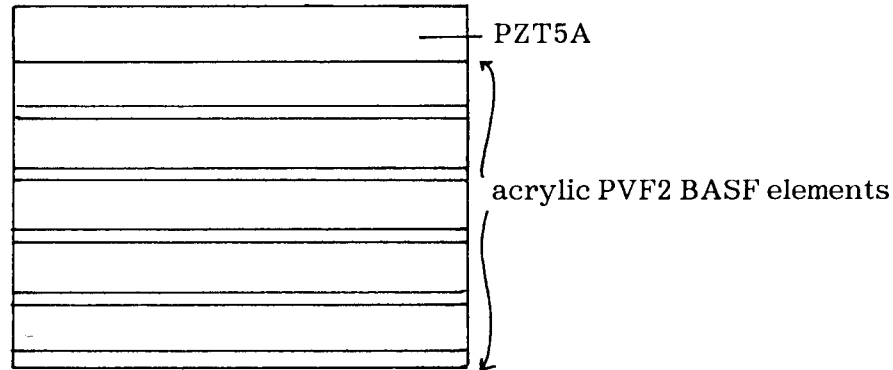

Fig. 3. Final stack assembly

threshold of the trigger circuit, the frequency could be tuned to match the oncoming wave. Thus, even though the delay through the stack was inconsistent due to the variation in the bonding thickness, the cascade of pulses could always be kept in phase with the advance of the compression wave. A straightforward sequential delay could not do this, which was why other attempts at 'sonic lasers' had failed to produce the expected amplification.

Everything worked fine except that as soon as the stack was moved, almost as soon as it was touched, the drive circuit would blow. This was surprising since this was no wimpy drive and had the capacity to deliver more than a joule per pulse. But closer examination revealed that the circuit was not blowing in the 'ON' cycle but in the 'OFF' cycle.

A sector of the stack was connected across an oscilloscope and the waveform in Fig. 4 was observed when a thermal gradient was across the stack while only noise was visible in the absence of the gradient.*

At first I naturally assumed that this pulse was a high impedance phenomenon, but I had to wait for a couple of days to investigate since it had blown the oscilloscope.

* Emphasis added by H. Aspden.

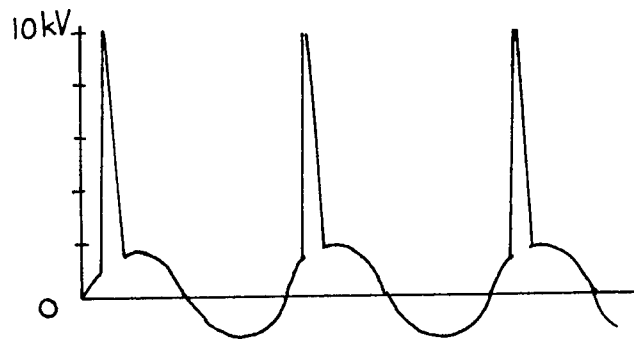

Fig. 4. Spike voltage waveform produced by thermal gradient

A charge amplifier arrangement with a virtual dead short was now attached to the sector of the stack and the waveform had the shape shown in Fig. 5. Note that both of these measurements are of a sector of the stack **not connected to the drive circuit**.

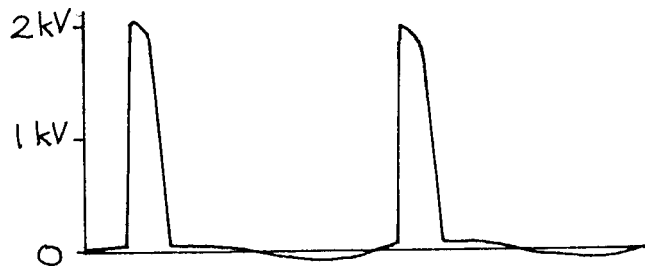

Fig. 5. Thermally developed spike voltage with circuit protection

This was very surprising. Clearly the spikes carried a lot of current and in fact even the impedance of the charge amplifier was too high to discharge the spike before it was driven off. As lower and lower impedances were tried it was eventually possible to discharge the spike in the 200 ns of its duration and get a measure of the number of joules involved.

This turned out to be broadly proportional to the temperature differential across the stack and reached a peak at about 0.05 of a micro joule at about 70° C temperature differential.

The lithotripter circuit was redesigned to short out the stacks behind the wavefront but even the VMOS kept blowing in the 'OFF' state now, as the voltages were just too high. This was bitterly disappointing since the acoustic energy in the pulse from a single full

25mm stack was truly immense and the full array would have been capable of pulverising a 10 mm stone to dust in a few seconds without the sharp edges in the remnant rubble that cause much trouble in laser lithotriptors. By this time, however, high power lasers were already beginning to fall in price and it seemed as though the window of opportunity for the device was closing.

I had reported the thermoelectric effect to Dr. Aspden at this stage and I had suggested that perhaps the pyroelectric and thermoelectric effects were interacting in some way. Dr. Aspden was sceptical and proposed a number of alternatives. I built some devices using diode arrays as disclosed in an early patent* but my experimental technique was appalling and so I cannot rely on the measurements made on the device.

The exact number of layers in each stack in the device tested to obtain the above signal waveforms is not known, since the acoustic thickness was all that mattered, but a fair estimate would be about 20 - 30 layers. Thus the assembly would represent 20 series stacks connected in parallel when connected as a finished assembly.

For the thermoelectric application I rewired the stack to produce a standing wave rather than a travelling wave and set up the circuit with a combination tuning transformer, thus creating a stack consisting of a combination of serial and parallel connections in a series resonant circuit with the stack and with an omnitron SCR.

The circuit configuration is as shown in Fig. 6.

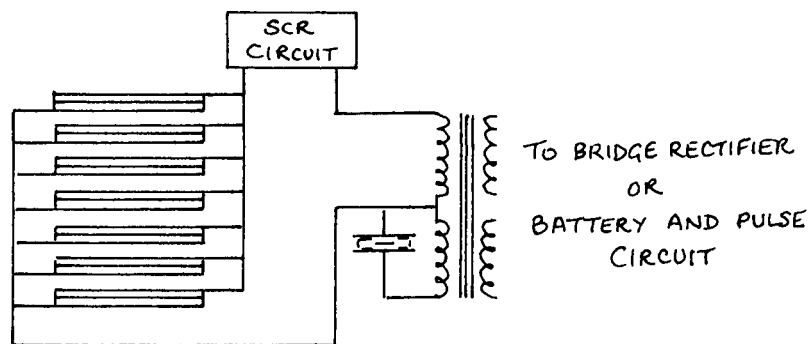

Fig. 6 Series-parallel connections of laminar stack

* This is the subject of U.S. Patent No. 5,065,085, whereas the later prototype laminar stack thermoelectric devices became the subject of U.S. Patent No. 5,288,336.

[Footnote by H. Aspden]

Off voltage was now less of a problem since the actual rising edge of the spike would turn on the CRS before the junction blew, but even so the resonant circuit meant that flyback voltages were still dangerous in the OFF condition. Keeping the output of the transformer coupled to low impedance prevented this from being terminal.

The amount of energy in each pulse is difficult to explain since the capacitance of the stack as measured by a bridge was far too low to account for the energy magnitude of the pulse. The combination of pyroelectric behaviour and thermoelectric behaviour seems to combine with either a sudden increase in the effective capacitance or perhaps a brief conductive phase through the PVF2. The resulting stack was connected to an input circuit and to an output path via a transformer and then through a rectifier circuit. The rectifier circuit should use very low voltage drop diodes to reduce voltage drop losses.

The rest of the story is well known* but a few points are worth making. The first and third prototype devices produced a reversible effect, ie. the provision of high energy electrical pulses to the stack resulted in the appearance of a dramatic temperature differential across the stack. The second device, built without the magnetic interface strips, did not do this and also was incapable of self-driving through an SCR. The electrical efficiency was measured accurately in terms of the transfer of heat and the electrical output of the device but the amount of breakthrough from the external drive circuit was ignored. Were the measurements valid?*** As I recall several results were surprising but were explained away by some fancy footwork from Dr. Aspden. The third device did indeed produce a reasonably impressive thermoelectric efficiency as a generator but detailed analysis of the measurements of the device as a heat pump show that its performance is nowhere near as efficient as would be expected. While this is explainable to some extent from the predicted behaviour of the protection circuitry, the fact remains that as a heat pump the device performs no better and perhaps worse than several commercially available heat pumps. What if the discrepancy between the thermoelectric generator effect and the heat pump effect is the result of a transient electrochemical effect? The chemical interaction of cyanoacrylate and metal is already known to be charge sensitive and is very temperature sensitive. This is a

This is a reference to the information which has been published by articles, conferences and patent specifications in endeavouring to promote interest in the Strachan-Aspden invention.

** Underlining by H. Aspden. This is a surprising statement. The tests in question are the subject of Appendix IV already presented. As stated on page 42 we used a function generator to provide an input signal to regulate electrical power delivery in pulsations at the control frequency. The signal input of a few volts was fed through a high-valued resistor so that minimal input current could 'break through' to feed power into the output circuit from the function generator. It would seem therefore that Strachan here is registering his own

personal reservations about the high operational efficiency of that now-defunct tested device.
[Footnotes by H. Aspden]

major nightmare for me. What if, in fact, all we have is an endothermic electrochemical reaction? Several gels exist that freeze when subjected to an electrical current. And a lot of those are acetates! The electrical generation effect is even more common.

The current device is now inert but it is likely that not all elements will have decayed. I am now dismantling the device and will attempt to recover as many elements as possible. I would propose the best use that could be made of these is to distribute them to various laboratories that propose to attempt to construct a device.

[End of Strachan's February 2, 1994 Communication]

Concluding Comment

It has become clear, and especially in the light of the above-stated position taken by Strachan, that ongoing experimental research on the phenomenon underlying the Strachan-Aspden invention will need to be undertaken by Strachan's coinventor, myself, as author of this Report, in following my own different convictions concerning base metal properties when activated thermoelectrically using a.c. However, I can but hope that research interests of those having the appropriate academic or corporate affiliations who come to read this Report will see the merit in the Nernst Effect interpretation of the transverse a.c. action, as described in the initial commentary of this Energy science Report No. 2, and will undertake their own investigations in pursuit of this new technology. The outcome of my own efforts will be reported in Energy Science Report No. 3.